

**EPSON® PowerLite® 5600p and 7600p
Multimedia Projectors**

User's Guide

Important Safety Information

WARNING: Never look into the projector lens when the lamp is turned on; the bright light can damage your eyes. Never let children look into the lens when it is on. Never open any cover on the projector, except the lamp and filter covers. Dangerous electrical voltages inside the projector can severely injure you. Except as specifically explained in this *User's Guide*, do not attempt to service this product yourself. Refer all servicing to qualified service personnel.

WARNING: The projector and its accessories come packaged in plastic bags. Keep plastic bags away from small children to avoid any risk of suffocation.

Caution: When you replace the lamp, never touch the new lamp with your bare hands; the invisible residue left by the oil on your hands may shorten the lamp life. Use a cloth or glove to handle the new lamp.

Copyright Notice

All rights reserved. No part of this publication may be reproduced, stored in a retrieval system, or transmitted in any form or by any means, electronic, mechanical, photocopying, recording, or otherwise, without the prior written permission of SEIKO EPSON CORPORATION. The information contained herein is designed only for use with this EPSON product. EPSON is not responsible for any use of this information as applied to other products.

Neither SEIKO EPSON CORPORATION nor its affiliates shall be liable to the purchaser of this product or third parties for damages, losses, costs, or expenses incurred by purchaser or third parties as a result of: accident, misuse, or abuse of this product or unauthorized modifications, repairs, or alterations to this product, or (excluding the U.S.) failure to strictly comply with SEIKO EPSON CORPORATION's operating and maintenance instructions.

SEIKO EPSON CORPORATION shall not be liable for any damages or problems arising from the use of any options or any consumable products other than those designated as Original EPSON Products or EPSON Approved Products by SEIKO EPSON CORPORATION.

EPSON is a registered trademark of SEIKO EPSON CORPORATION.

Extra Care is a service mark; EPSON Store and SizeWise are trademarks; and Presenters Club, PrivateLine, and PowerLite are registered trademarks of Epson America, Inc.

General Notice: Other product names used herein are for identification purposes only and may be trademarks of their respective owners. EPSON disclaims any and all rights in those marks.

C

Contents

Welcome

Getting the Most from Your Projector	2
Using Your Documentation	3
Reading This Manual Online	3
Getting More Information	4
Registration and Warranty	5
Unpacking the Projector	6
Additional Components	7
Optional Accessories	8

1 *Setting Up the Projector*

Positioning the Projector	10
Connecting to a Laptop Computer	12
Connecting the Computer Cable	12
Connecting the Cable for Remote Mouse Control	13
Amplifying Computer Audio	14
Connecting to Video Sources	15
Connecting an RCA Video Cable	16
Connecting an S-Video Cable	17
Connecting a Component (BNC) Video Cable	18
Connecting the Audio Cable	19

2 *Using the Projector*

Turning On Your Equipment	22
Turning On the Projector	22
What To Do If You See a Blank Screen	24

Adjusting the Image	26
Focusing and Zooming Your Image	26
Adjusting the Height of Your Image	27
Adjusting the Image Shape	27
Resizing the Image	28
Adjusting the Tracking and Synchronization	28
Controlling the Projector	29
Switching Between Picture Sources	29
Adjusting the Volume	29
Turning Off the Picture and Sound	29
Shutting Down the Projector	30

3 *Using the Remote Control*

Installing the Batteries	32
Turning On the Remote Control	32
Controlling the Picture and Sound	34
Switching Between Picture Sources	34
Adjusting the Volume	34
Turning Off the Picture and Sound	35
Stopping Action	35
Zooming Your Image	35
Displaying Picture-in-Picture Video	36
Highlighting Your Presentation	37
Using the Pointer	37
Using Box Highlights	38
Spotlighting Your Image	38
Using Horizontal and Vertical Highlights	39
Using the Remote Control as a Wireless Mouse	40

4 *Fine-tuning the Projector*

Using the Projector's Menu System	42
Changing Menu Settings	43
Adjusting the Image	45
Repositioning the Image	46
Adjusting Image Appearance	46
Saving and Recalling Computer Settings	47
Adjusting the Sound	48
Customizing the Highlighting Tools	49

Creating Your Own Startup Screen	51
Capturing the Image	51
Choosing When to Display the Image	52
Customizing Projector Features	53
Setting Advanced Features	54
Viewing Lamp Usage and Other Information	55
Restoring the Default Settings	56

5 *Maintaining and Transporting the Projector*

Cleaning the Lens	58
Cleaning the Projector Case	58
Cleaning and Replacing the Air Filter	59
Replacing the Lamp	60
Resetting the Lamp Timer	62
Transporting the Projector	63

6 *Solving Problems*

Using On-Screen Help	66
What To Do When the Lights Flash	67
Solving Problems with the Image or Sound	68
Solving Problems with the Remote Control	74
Where To Get Help	75
Telephone Support Services	75

Appendix A: Connecting to Additional Equipment

Installing the Projector	78
Controlling the Projector from a Computer	78
Connecting to an External Audio System	79
Connecting to a PC Desktop Computer	80
Connecting the Computer Cable	80
Connecting the Mouse Cable	81
Connecting the Audio Cable	82
Connecting to a Desktop Macintosh	83
Connecting the Computer Cable	83
Connecting the Mouse Cable	84
Connecting the Audio Cable	85
Connecting to a Second Computer	86
Connecting to a High-End Workstation	87
Connecting to a DVI Video Source	88

<i>Appendix B:</i>	Important Safety Instructions	89
<i>Notices</i>	Remote Control Information	91
	Declaration of Conformity	92
	FCC Compliance Statement	93

<i>Appendix C:</i>	General	95
<i>Technical</i>	Projection Lamp	96
<i>Specifications</i>	Remote Control	96
	Mouse Compatibility	96
	Remote IR Receiver	96
	Dimensions	96
	Electrical	96
	Environmental	97
	Safety	97
	Compatible Video Formats	97
	Interface Connectors	100
	Computer Video Port Pin Assignments	101
	Image Size and Projection Distance	102

Index

W *Welcome*

The EPSON® PowerLite® 5600p and PowerLite 7600p are portable projectors offering 2200 ANSI lumens of brightness. From boardrooms to auditoriums, your full-color presentations and videos will be bright and visible even in ordinary room lighting.

Images are displayed at a resolution of 1024 × 768 pixels (PowerLite 7600p) or 800 × 600 pixels (PowerLite 5600p). The 1.3-inch LCD provides a high contrast ratio for incredibly vivid images and clear text. Improved video processing reduces “color noise” for rich, saturated images, while reduced light leakage and whisper-quiet operation contribute to theater-quality video.

With EPSON’s patented SizeWise™ chip, the projector supports computer displays ranging from VGA through UXGA (or SXGA on the PowerLite 5600p). The projector also supports the new Digital Visual Interface (DVI) format.

You can connect the projector to a wide range of computers, including IBM® compatible PCs and laptops, Apple® Macintosh®, Power Macintosh™ series (including G3 and G4 systems), PowerBook® computers, many iMac™ and iBook™ series systems, and high-end workstations such as the Sun® SPARCstation.™

You can use any of the following video sources: VCR, DVD player, camcorder, digital camera, or laser disc player. The projector supports composite video, S-Video, and component video, and it automatically senses the video format (HDTV, NTSC, PAL, or SECAM).

Getting the Most from Your Projector

note

You can connect a maximum of four sources at the same time.

Your EPSON PowerLite projector is a highly versatile presentation tool. You can connect it to one or two computer sources and up to three video sources and easily switch between them. You can also include sound for up to two of the sources.

Depending on your presentation, you can take advantage of any or all of these options:

- **Connecting to a laptop or other computer**

If you want to connect to a PC laptop or Macintosh PowerBook, see page 12. To connect to a desktop computer, a workstation, a computer that outputs video in Digital Visual Interface (DVI) format, or more than one computer, see Appendix A.

- **Connecting to video sources**

You can connect a DVD player, VCR, camcorder, laser disc player, digital camera, or any other video source to your projector. You can connect up to three video sources at the same time (with or without a computer) and easily switch between them. See page 15 for instructions.

- **Using the remote control**

The remote control lets you switch from one computer or video source to another, with access to picture-in-picture, pointer, zoom, and many other projector features. For details, see “Using the Remote Control” on page 31.

By connecting an additional cable, you can also use the remote control as a wireless mouse. This lets you click through slideshow-style presentations (such as PowerPoint®) from up to 30 feet away. For more information, see page 40.

- **Including sound in your presentation**

If your presentation includes sound, you can connect an audio cable to use the projector’s built-in stereo speakers. For details, see page 14 (for laptops) or Appendix A (for other systems).

If you’re permanently installing the projector, you may wish to connect external speakers or a public address system to the projector’s **Audio Out** port; see page 79.

■ Controlling Your Projector from a Computer

If you want to be able to control the projector's settings from your computer (for example, if the projector is ceiling-mounted), you can install the EMP Link V program on the Projector Software CD-ROM. For details, see page 78.

note

The EMP Link program is optional; you do not need to install it to use the projector.

Using Your Documentation

To connect the projector to your laptop and get your presentation up and running fast, see the *Quick Setup* sheet in your *Owner's Kit*.

This book contains all the information you need to set up and use your projector. Please follow these guidelines as you read through it:

- Warnings must be followed carefully to avoid bodily injury.
- Cautions must be observed to avoid damage to your equipment.
- Notes contain important information about your projector.

Reading This Manual Online

Your PowerLite 5600p/7600p CD-ROM includes an electronic copy of this manual. You may find it convenient to copy it onto your laptop's hard drive so it's always with you—for example, when taking your presentation on the road.

To view your electronic manual, you need to use Adobe® Acrobat® Reader. Just insert the CD-ROM in your CD-ROM drive, select the Install/View User's Guide button and click Install User's Guide or View User's Guide.

When you open the manual, you see this toolbar:

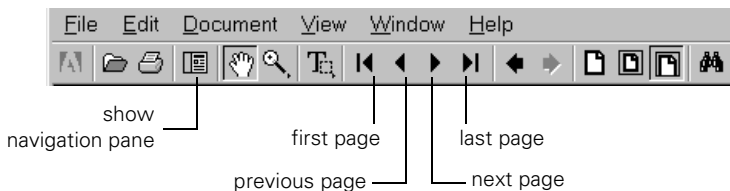

note

If you do not have Acrobat Reader, you can install it from the CD-ROM.

note

If the hand changes to an index finger while holding the mouse pointer over text, you can click to jump to a related topic.

You can move quickly to the topic of your choice by clicking in the table of contents on the left side of the screen. You can also use the arrow buttons in the toolbar or on the vertical scroll bar on the right side of the screen to move through the manual.

For more information, see your Acrobat Reader online guide.

Getting More Information

Need tips on giving presentations? Quick steps for setting up your projector? Here's where you can look for help:

- **presentersonline.com**
Includes a library of articles covering presentation tips, tricks, and technology. The site provides templates, clip art and sound clips, as well as Presenters Services to use on the road. Even more resources and services are available if you register to join the Presenters Club®—and it's free.
- **Quick Setup sheet**
Gives you all the instructions you need to get your projector set up and connected to a laptop or PowerBook computer.
- **Owner's Kit folder**
Includes your *Quick Setup* sheet, warranty brochures, CD-ROMs, and EPSON PrivateLine® Support card. Store this *User's Guide* in the folder and keep the folder with your projector at all times.
- **Built-in help system**
Provides assistance for common problems. Available from the **Help** button on the projector or the remote control. See page 66 for details.
- **support.epson.com**
Download FAQs and e-mail your questions to EPSON support.
- **CD-ROMs**
Your *Owner's Kit* includes two CD-ROMs. The PowerLite 5600p/7600p CD-ROM lets you register electronically and includes an electronic copy of this book as well as a link to *Presenters Online*. On the Projector Software CD-ROM, you'll find the optional EMP Link V program and its *User's Guide*.

note

You don't need to install any software to use your projector.

If you still need help after checking this *User's Guide* and the sources listed above, you can use the EPSON PrivateLine Support service to get help fast. Call (800) 637-7661 and enter the PIN on the card in your *Owner's Kit*. Or take advantage of EPSON's automated support services 24 hours a day. See page 75 for more information.

Registration and Warranty

Your projector comes with a basic carry-in warranty as well as an international warranty that let you project with confidence anywhere in the world. For details, see the warranty brochures included in your *Owner's Kit*.

In addition, for customers who register their projector, EPSON offers free Extra CareSM Road Service. In the unlikely event of an equipment failure, you won't have to wait for your unit to be repaired. Instead, EPSON will ship you a replacement unit anywhere in the United States or Canada via overnight delivery. See the brochure in your *Owner's Kit* for details.

To register, simply insert the PowerLite 5600p/7600p CD-ROM that came with your projector and select **Register Online**. Registering also lets you receive special updates on new accessories, products, and services. You can register through the Internet, by e-mail or 800-number modem connection, or by printing out the form to fax or mail.

Unpacking the Projector

After unpacking the projector, make sure you have all the parts shown below:

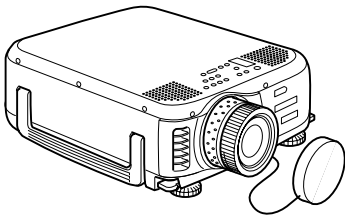

projector



remote control



EPSON PowerLite 5600p/7600p
CD-ROM (not needed to use your
projector)



batteries

Projector Software
CD-ROM (optional)

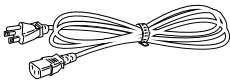

power cord

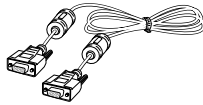

computer cable

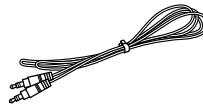

computer audio cable



RCA audio cable



RCA video cable

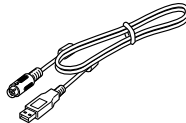

USB mouse cable

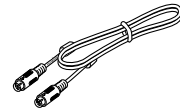

PS/2[®] mouse cable

Save all packaging in case you need to ship the projector. Always use the original packaging (or the equivalent) when you need to send the projector to another location.

If you are moving the projector by hand, use a carrying case (such as the optional cases available from EPSON). See page 8 for more information about cases.

Additional Components

Depending on how you plan to use the projector, you may need additional components:

- To receive an S-Video signal, you need an S-Video cable. (One is usually provided with your video device.)
- To receive a component video signal from a VCR or other video device having BNC connectors, you need a VGA-to-3BNC cable. You can purchase this from EPSON; see page 8.
- To connect two computers to the projector at the same time, you need an additional VGA computer cable like the one included with the projector. To amplify the second computer's audio through the projector's sound system, you need an RCA-to-3.5 mm stereo cable. See your computer or electronics dealer to obtain these cables.
- Some older PowerBooks and Macintosh desktop models may need the Macintosh adapter set shown on page 83 (available from EPSON; see page 8). Older iMac systems may need a special adapter to provide a VGA output port; see your computer dealer.
- Some systems may need an additional cable to use the remote control as a wireless mouse. If your Macintosh doesn't have a USB port, you'll need a Macintosh mouse cable. If your PC doesn't have a USB or PS/2 port, you'll need a PC serial mouse cable. See your projector dealer to obtain the correct cable.
- If you plan to use the EMP Link V software to control the projector, you'll need a standard serial cable, which you may purchase from your computer dealer.
- To take advantage of the projector's Digital Visual Interface, you need a DVI cable, and your computer must be capable of producing video signals in DVI format (for details, see page 88). You can purchase this cable from EPSON; see page 8.

Optional Accessories

To enhance your use of the projector, EPSON provides the following optional accessories:

Product	Product number
Replacement lamp and air filter	ELPLP12
Long throw zoom lens	ELPAL01
Wide angle lens	ELPAW01
Customized carrying cases: Samsonite® wheeled soft case ATA molded hard shell case ATA shipping case	ELPKS35 ELPKS38 ELPKS39
Ceiling mount	ELPMB34
Suspension adapter for ceiling mount	ELPMBAST
Kensington security lock	ELPSL01
Projection screens: 50-inch portable screen 60-inch Insta Theatre screen 80-inch Insta Theatre screen	ELPSC06 ELPSC07 ELPSC08
Wireless microphone and two satellite speakers	ELPCUS1
Auxiliary audio system	ELPPAS1
Remote control receiver (plugs into projector to extend range of remote control)	ELPST02
Remote control receiver kit (includes standard receiver and clip-on receiver for attachment directly to remote control)	ELPST04
Macintosh adapter set (includes monitor adapter and desktop adapter)	ELPAP01
Component video cable (VGA to 3BNC)	ELPKC19
Digital video cables: DVI to DVI, 10 feet (3 meters) DVI to DFP, 10 feet (3 meters)	ELPKC20 ELPKC21

You can purchase these accessories from your dealer, by calling EPSON at (800) 873-7766, or by visiting www.epsonstore.com (U.S. sales only). In Canada, please call (800) 873-7766 for dealer referral.

1 *Setting Up the Projector*

This chapter tells you how to set up the projector for a laptop computer or video presentation. If you need to set up the projector for a permanent installation or connect it to a desktop or workstation computer, see Appendix A.

You'll find instructions for the following in this chapter:

- Positioning the projector
- Connecting to a laptop computer
- Connecting to video sources

Positioning the Projector

Before connecting the projector, you need to decide where to place it. The location you choose depends on the size of the room and what you are projecting.

caution

Don't hold or lift the projector by the lens, or you may damage it.

note

It's easier to position the projector when the screen is directly in front of the room. If the screen is placed diagonally in a corner, it's much more difficult to aim the projector correctly at the screen and get a square image.

- Place the projector on a sturdy, level surface, approximately 3.6 to 48 feet from the screen.
- Make sure there is plenty of space for ventilation around and under the projector.
- Make sure the projector is within 10 feet of a grounded electrical outlet or extension cord, and within 5 feet of your computer and/or video source.
- Place the projector directly in front of the center of the screen, facing it toward the screen squarely. Otherwise, your image will not be square.

Most presenters find it convenient to place the projector in front of the audience, leaving as much space as possible between the projector and the screen to get a good-sized image. This lets the presenter stand in the front of the room, face the audience, and remain close enough to the equipment to be able to control it.

Use the figure below as a guideline to help you determine how far from the screen to place the projector. Image size generally increases with distance, but may vary depending on how you position the zoom ring and whether you have adjusted the image size with other settings. The dimensions shown are based on using the standard lens.

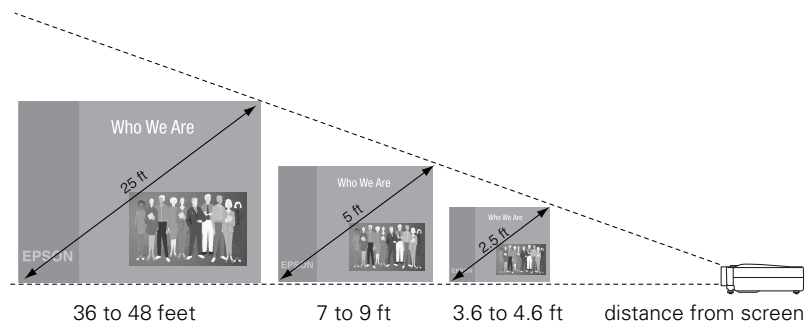

If you place the projector below the level of the screen, you'll have to tilt it up by extending the feet as shown. Tilting the projector upward causes the image to lose its square shape, but you can correct the distortion by pressing the **Keystone** button as described in the next chapter.

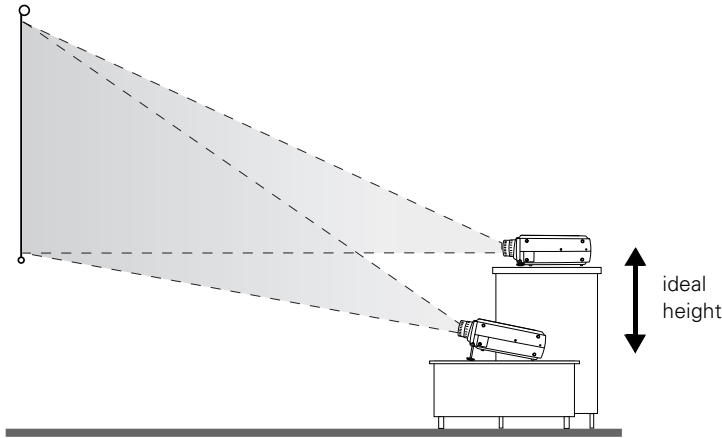

If you place the projector level with the bottom of the screen, the image will be square and you won't have to adjust it. If you place the projector higher than the bottom of the screen, the image will still be square, but you won't be able to fill the whole screen with the image.

note

After positioning the projector, you may want to connect a Kensington MicroSaver® anti-theft device to the lock port on the projector's left side. You can purchase this from EPSON; see "Optional Accessories" on page 8.

Connecting to a Laptop Computer

note

To connect to desktops and other computer systems, see Appendix A. If you have an iBook with an RCA video-out port, follow the instructions for connecting to a video device on page 16.

You can connect the PowerLite projector to any computer that has a standard video output (monitor) port, including PC notebook and laptop computers, Macintosh PowerBooks, and hand-held devices.

Connecting the Computer Cable

Before you start, make sure your computer and the projector are turned off.

1. Connect one end of the computer cable to the projector's Computer 1 port.

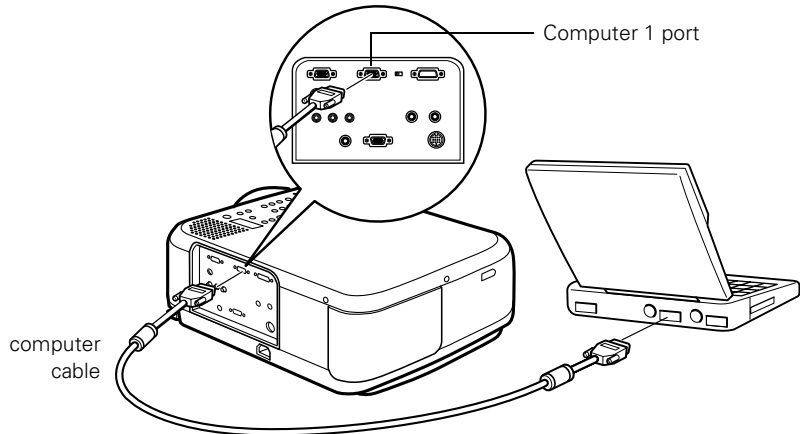

2. Make sure the Computer 1 switch is flipped to the left (to the Analog position, as shown). If necessary, use the tip of a ballpoint pen to slide it over.
3. Connect the other end of the computer cable to your laptop's video-out or monitor port.

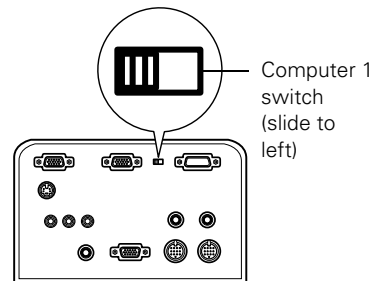

note

Laptop configurations vary. See your computer manual for the location of the ports needed to connect your projector.

If you're using a PowerBook and you can't connect the cable, you may need to use the Macintosh desktop adapter as shown on page 83 (available from EPSON; see page 8).

4. Tighten the screws on the connectors.

If you don't need to make any other connections, you can plug in your projector and turn it on. See page 22 for instructions.

Connecting the Cable for Remote Mouse Control

Using the remote control as a wireless mouse lets you control your computer and click through slideshow-style presentations, such as PowerPoint, from up to 30 feet away (for details, see page 40). This gives you more flexibility in delivering your presentation, since you won't need to stand near your computer.

1. Locate the cable you need, depending on whether your laptop has a round PS/2 mouse port or a flat USB mouse port.
2. Connect the round end of the cable to the projector's **Mouse1** port, as shown.

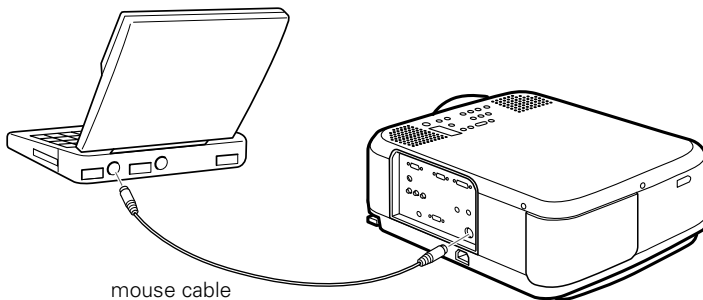

3. Connect the other end of the cable to the external mouse port or USB port on your laptop.
4. If necessary, configure your laptop to work with an external mouse.

If you don't need to make any other connections, you can plug in your projector and turn it on. See page 22 for instructions.

note



If you're using a PowerBook that has a round mouse port, you'll need a Macintosh mouse cable. If you have a PC laptop with a serial mouse port, you'll need a serial mouse cable. See your projector dealer to obtain the correct cable.

Amplifying Computer Audio

Your laptop probably has its own sound system; however, it may not be adequate for your presentation. If you need more volume or better sound quality, you can connect the audio cable to take advantage of the projector's built-in amplifier and stereo speakers.

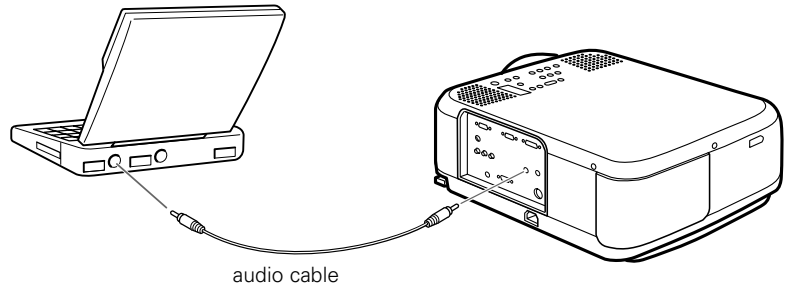
1. Connect one end of the audio cable to the **Audio (Computer1)** jack on the projector.



2. Connect the other end of the audio cable to your laptop's  headphone jack or  audio-out jack. (Jack locations vary; see your computer manual if you're not sure of which jack to use.)

If you don't need to make any other connections, you can plug in your projector and turn it on. See page 22 for instructions.

Connecting to Video Sources

You can connect a DVD player, VCR, camcorder, laser disc player, digital camera, or any other compatible video source to your projector.

The projector supports HDTV, NTSC, PAL, and SECAM, and automatically detects the video format. (However, if you're using a 60-hertz PAL system, you'll need to select **PAL60** in the Video menu, as described on page 47.)

The projector can receive composite video, S-Video, and component video. You can connect one or more of these video sources at the same time. However, these sources share the same audio input port, so you can connect audio for only one of the sources (see page 19).

The type of cable you use depends on whether you have composite video, S-Video, or component video.

- For composite video, use the RCA video cable included with the projector.
- For S-Video, use the S-Video cable supplied with your video device or obtain one from your electronics dealer.
- For component video, you'll need a VGA-to-3BNC cable. You can purchase this from EPSON; see page 8.

See the following illustration if you're not sure which type of connectors you have.

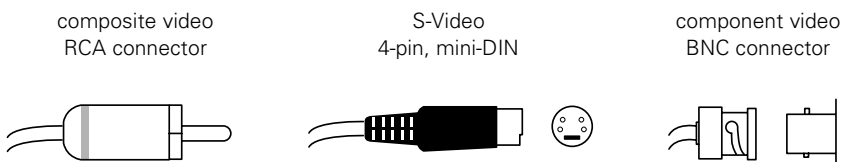

Follow the instructions below for your type of connection.

note

The projector does not support TV antenna cable F-connectors.

Connecting an RCA Video Cable

Before starting, make sure the projector and your DVD player or other video source are turned off.

1. Connect the yellow plug on one end of the RCA video cable to the projector's Video jack.

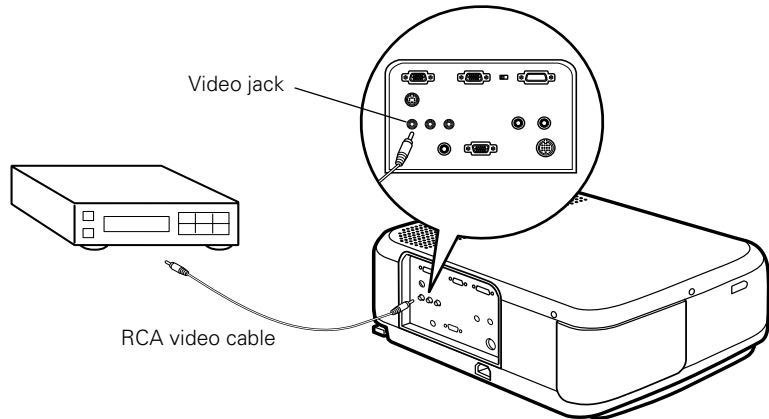

2. Connect the other end of the cable to the video-out jack on your video source.

To include sound in your presentation, connect the RCA audio cable as described on page 19.

Connecting an S-Video Cable

If your video source has an S-Video jack, you can use it to project a higher quality video image. However, you'll need an S-Video cable, which may be included with your video source, or can be purchased separately.

Before starting, make sure the projector and your DVD player or other video source are turned off.

1. Insert one end of an S-Video cable into the projector's S-Video connector.

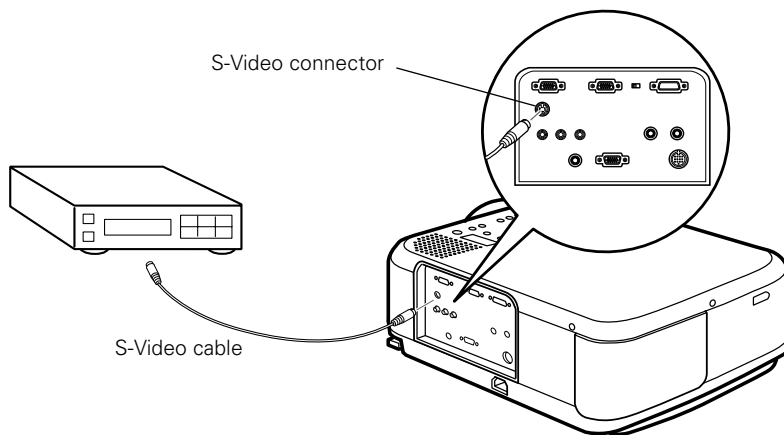

2. Insert the other end into the S-Video output port of your video source.

To include sound in your presentation, connect the RCA audio cable as described on page 19.

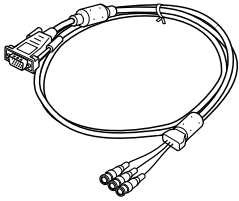

Connecting a Component (BNC) Video Cable

If your video source has component (BNC) connectors, you can use them to project a higher quality video image. However, you'll need a VGA-to-3BNC video cable, which is available from EPSON; see page 8.

Before starting, make sure the projector and your DVD player or other video device are turned off.

1. Connect the VGA end of the cable to the projector's **Computer 2/Component Video** port.

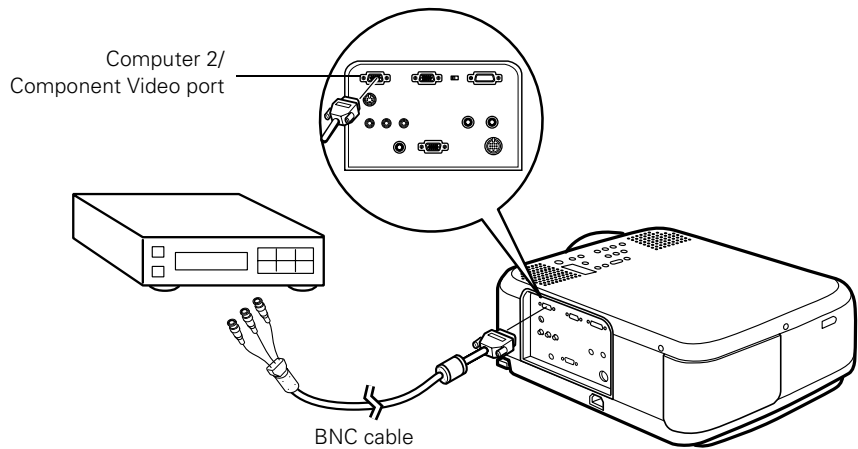

2. Connect the red, green, and blue leads at the opposite end of the cable to the corresponding connectors on your video source.
3. If the image doesn't display properly, you may need to change the **BNC** option in the projector's Setting menu (see page 54).

To include sound in your presentation, connect the RCA audio cable as described on page 19.

Connecting the Audio Cable

To include sound in your video presentation, you need to connect the RCA audio cable that came with your projector. If you've connected more than one video source, you can include sound for just one of the sources. (You can also include sound for your computer source; see page 14.)

1. Connect the RCA audio cable to the left and right **Audio 2** jacks on the projector (insert the white plug into the L port and the red plug into the R port).

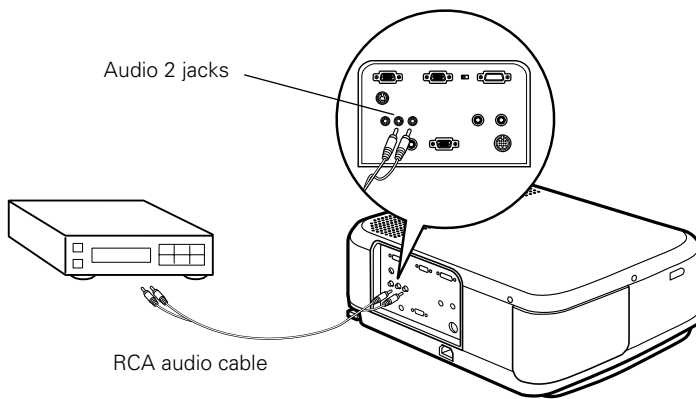

2. Connect the plugs at the other end of the cable to the audio output jacks on your video source.

2

Using the Projector

Once you've connected the projector to your computer or other equipment (as described in Chapter 1 or Appendix A), you're ready to turn on the projector, adjust the image, and give your presentation.

Although you can operate the projector without it, the remote control lets you use additional features. See Chapter 3 for instructions on using the remote. This chapter covers the following:

- Turning on the projector and other equipment
- Adjusting the image
- Controlling the projector
- Shutting down the projector

Turning On Your Equipment

Make sure your projector and other equipment are set up and connected correctly, as described in Chapter 1 or Appendix A. Then turn on your projector, as described below, followed by any equipment you've connected to it. You can turn on your computer and video equipment in any order, but if you have more than one computer or video source connected, you may have to switch to the desired source as described on page 29.

Turning On the Projector

Follow these steps to plug in and turn on the projector:

1. Connect one end of the power cord to the projector's power inlet.

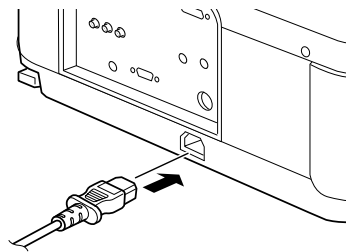

2. Connect the other end to a grounded electrical outlet.
The power light on the projector's control panel turns orange, indicating that the projector is receiving power but not yet turned on.
3. Remove the lens cap.

4. Press the red **Power** button on top of the projector.

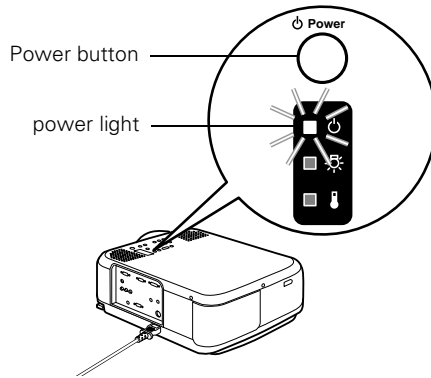

The power light flashes green as the projector warms up, and the projection lamp comes on in about 30 seconds. The power light stays green, and you may see a blue screen with the **No Signal** message displayed. This is normal.

5. Do one of the following:

- Turn on or restart your computer. In a few moments, you should see your computer display projected.

(Windows only: If you see a New Hardware Found message saying that it has found a plug-and-play monitor, click **Cancel**.)

- If you're projecting a video, press the **Play** button on your video source.

If a projected image fails to appear, see the next section for help.

Once you see your image, turn to page 26 for instructions on focusing and making other image adjustments.

When you're done with your presentation, shut down the projector as described on page 30. Shutting down the projector correctly prevents premature lamp failure and possible damage to the projector from overheating.

warning

Never look into the lens when the lamp is on. This can damage your eyes, and is especially dangerous for children.

What To Do If You See a Blank Screen



If you see a blank screen or a blue screen with the **No Signal** message after turning on your computer or video source, try the following:

- Make sure the cables are connected correctly, as described on page 12 (for laptops) or in Appendix A (for other systems).
- Make sure the power light is green and not flashing and the lens cover is off.
- Try restarting your computer.
- If you've connected more than one computer and/or video source, you may need to press the **Computer** or **Video** button on top of the projector to select the correct source. (Allow a few seconds for the projector to sync up after pressing the button.)

If you're using a PowerBook:

You may need to set up your system to display on the projector screen as well as the LCD screen. Follow these steps:

1. From the Apple menu, select **Control Panels**, then click **Monitors and Sound**.
2. Click the **Arrange** icon.

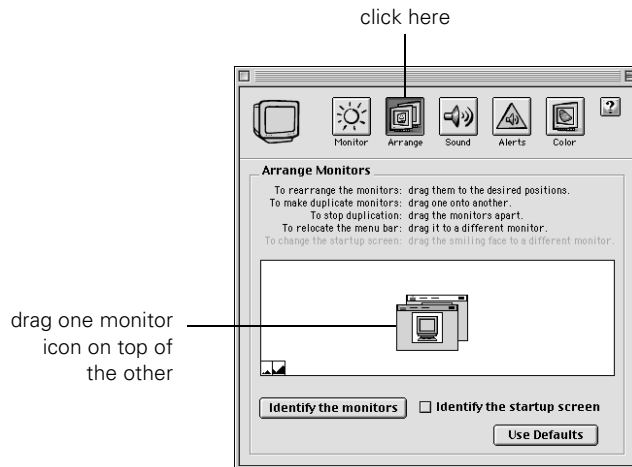

3. Drag one monitor icon on top of the other.

If the Arrange option isn't available, you may need to select one of the Simulscan resolution settings:

1. Click the **Monitor** icon.

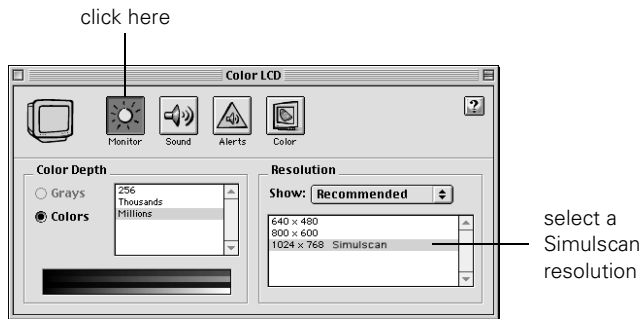

2. Select a **Simulscan** resolution as shown. (Allow a few seconds for the projector to sync up after making the selection.)

If you're using a PC laptop:

- Press the function key that lets you display on an external monitor. It's often labelled with an icon such as  but it may also be labelled **CRT/LCD**. You may have to hold down the **Fn** key while pressing it. Check your laptop's manual or online help for details.

On most systems, the  key lets you toggle between the LCD screen and the projector, or display on both at the same time. Allow a few seconds for the projector to sync up after pressing it.

- Depending on your computer's video card, you might need to use the Display utility in the Control Panel to make sure that both the LCD screen and external monitor port are enabled. See your computer's documentation or online help for details.

Adjusting the Image

Once you see your image, you'll need to make certain adjustments:

- To focus or zoom your image, see below.
- If the image is too high or too low, you can reposition it. See page 27.
- If the image isn't square, see page 27.
- If only part of a computer image is displayed, you may need to press the **Resize** button. See page 28 for more information.
- If the projected image has vertical stripes or bands, see page 28.

Focusing and Zooming Your Image

Rotate the focus ring to sharpen the image.

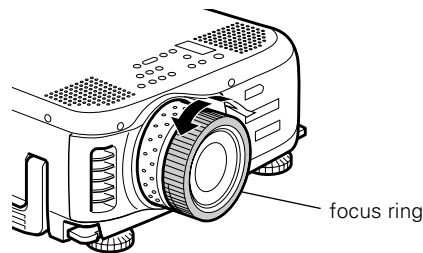

Rotate the zoom ring to reduce or enlarge the image.

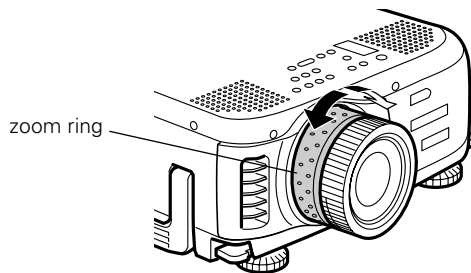

If the image still isn't large enough, you may need to move the projector farther away from the screen. You can also use the **E-Zoom** button on the remote control to zoom in on a portion of the image. See page 35 for instructions.

Adjusting the Height of Your Image

If the image is too low, you can raise it by extending the projector's feet.

1. Stand behind the projector. Pull up the blue foot release levers and lift the front of the projector. This unlocks the feet.

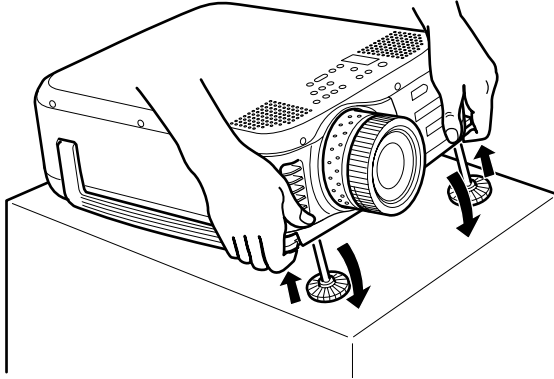





2. Once the image is positioned where you want it, release the levers to lock the feet in position.
3. To fine-tune the height of the image, rotate the thumb wheels attached to the projector's feet.

If the image is no longer square after raising it, see the next section.

Adjusting the Image Shape

If the projected image isn't square or has a "keystone" shape, do one or more of the following:

- If your image looks like  or , you've placed the projector off to one side of the screen, at an angle. Move it directly in front of the center of the screen, facing the screen squarely.
- If your image looks like  or , press the + or – side of the **Keystone** button to correct the shape of the image. After correction, your image will be slightly smaller.

You can also perform electronic keystone correction using the projector's Setting menu. See page 53.

caution

Do not hold the projector by the lens; this can damage it.

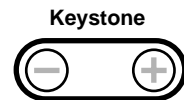

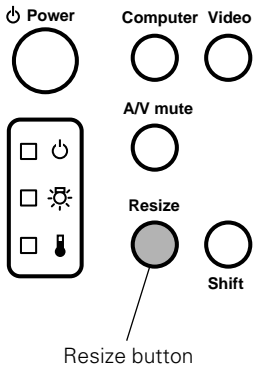

Resizing the Image

Some computer images need to be resized to display in the projector's native resolution. If only part of your computer image is displayed, you can correct it with the **Resize** button.

- Press the **Resize** button on the control panel. The screen image is automatically compressed.
- Continue pressing the **Resize** button to pan around the screen in the original resolution.

If you're projecting from video equipment, pressing the **Resize** button switches the aspect ratio between 4:3 and 16:9. If you've zoomed in on your image (using the **E-Zoom** button on the remote), you can press the **Resize** button to return it to the original display size.

Adjusting the Tracking and Synchronization

If you're projecting from a computer and displaying an image that contains a lot of detail (such as the text of a letter), you may notice one or more vertical stripes or bands, or some of the characters may look heavy or blurred. You can increase the clarity by pressing the **Enter** button on the control panel (or the **Auto** button on the remote control). This resets the projector's tracking, sync, and position settings.

If further adjustment is needed, you can correct the image manually using the **Tracking** and **Sync** buttons as described on page 72.

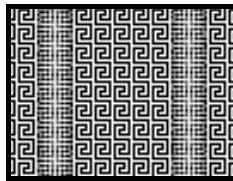
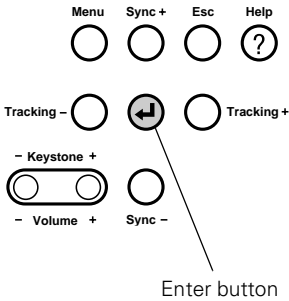

incorrect tracking

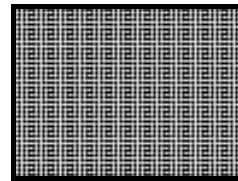

incorrect sync

Controlling the Projector

While giving your presentation, you may want to switch between picture sources, adjust the volume, or temporarily turn off the picture and sound. Follow the instructions below to access these features from your projector's control panel. You can also access these features, plus many others, using the remote control as described in Chapter 3.

Switching Between Picture Sources

If your projector is connected to more than one computer and/or video source, you can use the buttons on the control panel (or remote control) to switch between the different sources.

On the control panel, press the **Computer** button to switch between the computer sources and press the **Video** button to switch between standard (composite) video, S-Video, and component video (BNC).

After you select a source, the screen goes dark for a moment before the image appears.

Adjusting the Volume

If your presentation includes sound, you can adjust the volume from the projector's control panel. Hold the **Shift** button down while pressing the + or - side of the **Volume** button .

Turning Off the Picture and Sound

You can use the **A/V Mute** button on the control panel to darken your screen and turn off the sound. This is useful if you want to temporarily re-direct your audience's attention without the distraction of a bright screen.

- To turn off the picture and sound, press the **A/V Mute** button. The screen goes dark.
- To turn the picture and sound back on, press the button again.

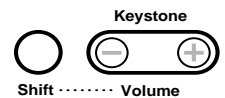
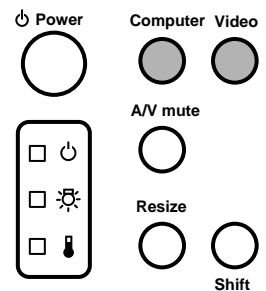

note

You can also have an image, such as a company logo, display on the screen whenever you press the A/V Mute button. See page 51 for instructions.

Shutting Down the Projector

note

When the projector has not received any input signals for 30 minutes, it automatically turns off the projector lamp and enters “sleep mode.” This conserves electricity, cools the projector, and extends the life of the lamp. If you are done using the projector, unplug the power cord. If you want to start projecting again, press the Power button.

When you’ve finished using the projector, follow the recommended procedure to shut it down. This extends the life of the lamp and protects the projector from possible overheating.

1. If you’ve connected a computer or laptop and it’s displaying only through the projector (the computer’s monitor is disconnected or turned off), shut down the computer first; otherwise you may not be able to see your computer’s display to shut it down properly.
2. To turn off the projector, press the red **Power** button on the projector or remote control. You see a confirmation message. (If you don’t want to turn it off, press any other button.)

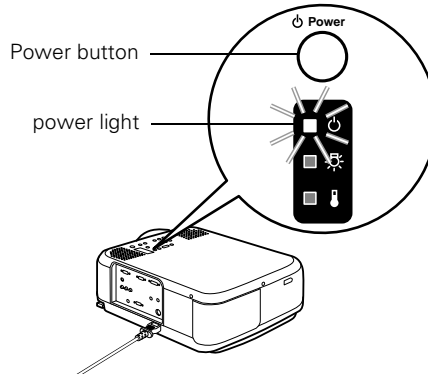

3. Press the **Power** button again. The power light flashes orange for about a minute as the projector cools down. When the projector has cooled, the orange light stays on and the exhaust fan shuts off.
If you want to turn the projector on again, wait until the orange light stops flashing. Then press the **Power** button.
4. Replace the lens cap and unplug the power cord.
5. If you’re using a VCR or other video source, turn it off after you turn off the projector.
6. Disconnect all equipment, and store the projector in a protective case.

caution

To avoid damaging the projector or lamp, never unplug the power cord when the power light is green or flashing orange.

3 *Using the Remote Control*

The remote control lets you access your projector's features from anywhere in the room—up to 30 feet away. You can use it to turn the projector on and off, control the picture and sound, and highlight your presentation by using it as a digital pointer.

If you've connected the mouse cable (as described in Chapter 1 or Appendix A), you can even use the remote control as a wireless mouse to control your computer or click through your slideshow-style presentations.

This chapter covers the following information:

- Installing the batteries
- Turning on the remote control
- Controlling the picture and sound
- Highlighting your presentation
- Using the remote control as a wireless mouse

Installing the Batteries

Follow these steps to install the remote control's batteries:

caution

When replacing batteries, take the following precautions:

- Don't mix old and new batteries.
- Replace batteries as soon as they run out. If the batteries leak, wipe away battery fluid with a soft cloth. If fluid gets on your hands, wash them immediately.
- Remove batteries if you won't be using the remote control for a long time.

1. Press the tab to release the battery compartment cover.

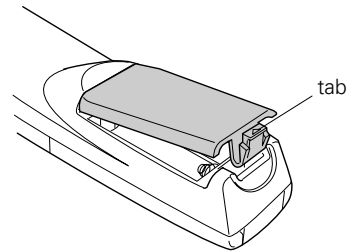

2. Remove the cover and insert the two AA batteries included with the projector as shown.
3. Replace the battery compartment cover.

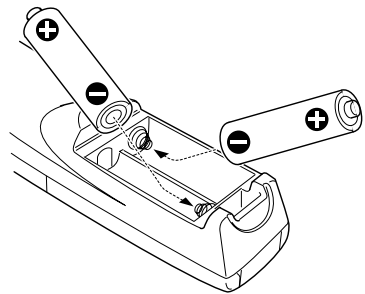

Before you can use the remote control, you need to turn it on as described below.

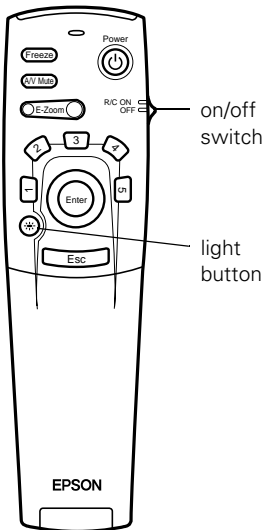

Turning On the Remote Control

Make sure the batteries are installed. Then push up the on/off switch on the side of the remote control to turn it on.

If you want to make sure the batteries are good, press the round ☀ light button. The other buttons on the remote should light up temporarily. If they don't, you need to change the batteries as described above.

Turn off the remote control before transporting it or storing it with the projector in a carrying case; this prevents the batteries from discharging if something presses against one of the remote control's buttons.

Keep the following in mind when using the remote control:

- Stand within about 30 feet of the projector. You can point the remote control either at the front or back of the projector or at the screen (the projector's front sensor can detect signals bounced off the screen).
- For some functions, you need to use the **Enter** button like a mouse to navigate on the screen. Press the edge of the button with your thumb—or grasp it between your thumb and finger and tilt it in the direction you want to move.
- To access additional buttons, pull down the cover below the **Esc** button.

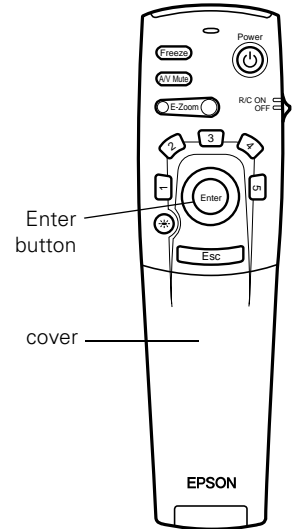

Controlling the Picture and Sound

You can use the remote control to select your source, adjust the volume, temporarily turn off the picture and sound, freeze the action, zoom in on the picture, or display a picture-in-picture video image. Make sure you have set up your projector and connected your audio or video source as described in Chapter 1 or Appendix A.

Switching Between Picture Sources

If you've connected your projector to more than one computer and/or video source, you can use the buttons on the remote control (or the control panel) to switch between the different sources.

- Press the **Video** button to switch between a standard composite video source and an S-Video source.
- Press the **Comp1** button to select your first computer.
- Press the **Comp2/YCbCr** button to select your second computer or a component video source.

After you select a source, the screen goes dark for a moment before the image appears.

Adjusting the Volume

If you've connected an audio source to the projector, you can adjust the sound that's output through the projector's speakers.

- To increase the volume, press on the right (+) side of the **Volume** button.
- To reduce the volume, press on the left (-) side of the **Volume** button.

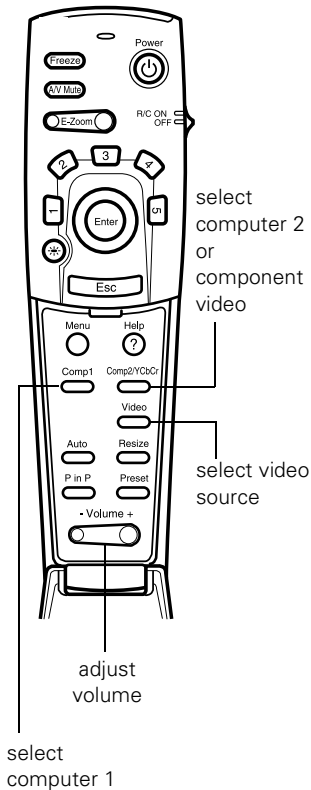

Turning Off the Picture and Sound

You can use the A/V Mute button on the remote control to darken your screen and turn off the sound. This is useful if you want to temporarily re-direct your audience's attention without the distraction of a bright screen.

- To turn off the picture and sound, press the A/V Mute button. The screen goes dark.
- To turn the image back on, press the button again.

Stopping Action

You can use the remote control to stop the action in your video or computer image.

- Press the Freeze button to stop the action and keep the current image on the screen. The sound will continue.
- Press the Freeze button again to re-start it.

Zooming Your Image

You can zoom in on a portion of the image using the E-Zoom button on the remote control.

1. Press the right side of the E-Zoom button to zoom in on your image; you can enlarge it up to four times its original size. You can press the button repeatedly (up to 32 times), or press and hold the button to zoom to the size you want.
2. Use the Enter button to pan around the screen if necessary.
3. Press the left side of the E-Zoom button to zoom out. You can press the button repeatedly, or press and hold it to zoom all the way out. You can also press the Resize button to return to the original size.

note

You can also have an image, such as a company logo, display on the screen whenever you press the A/V Mute button. See page 51 for instructions.

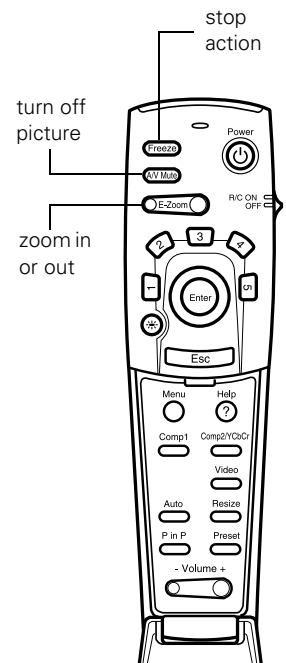

Displaying Picture-in-Picture Video

You can open a small video window on your computer image, and view a video at the same time as your computer presentation.

First make sure you have connected your VCR or other video source using an RCA or S-Video cable as described in Chapter 1. (You can't display the picture-in-picture window using component video.) If you're using S-Video, you need to select it in the **P in P** menu option as described on page 53.

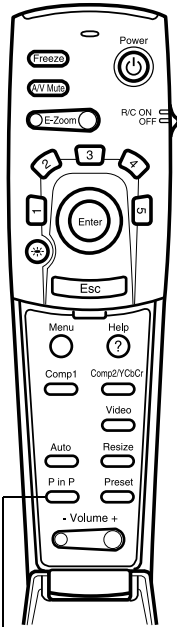

display
picture in
picture

1. Press the **P in P** button on the remote control. The screen may go dark for a moment, and then your video image appears in a small window on the screen. A menu appears in the lower left corner of the screen, describing how to move and resize the image.
2. Use the **Enter** button to reposition the video window on the screen. You can use the **E-ZOOM** button to enlarge or reduce the video window.
3. When the window is located and sized the way you want, press the **Enter** button. The menu disappears, and your video plays on the screen.



video window

4. When you're finished viewing the picture-in-picture, press the **P in P** button again. The video window disappears.

Highlighting Your Presentation

You can highlight areas on the screen using the numbered buttons on the remote control. You can use these “special effects” features to annotate your presentation slides or call attention to your most important points. Five highlighting tools are available:

- Pointer or cursor stamp (button 1)
- Box (button 2)
- Spotlight (button 3)
- Bar (button 4)
- Erase (button 5)

You can customize the highlighting tools through the Effect menu. See page 49 for instructions.

Using the Pointer

You can choose from three types of pointers and place them anywhere on your screen.

1. To activate the pointer tool, press button 1 on the remote control. A  colored pointer appears in the upper left corner of the screen. To try a different look, press 1 again. Press 1 again to see the third one.
2. Use the **Enter** button to place the pointer wherever you want it.
3. To “paste” the pointer on the screen, press down in the center of the **Enter** button. You can then continue to work with another pointer, moving it around the screen or pasting it wherever you want.
4. To erase the pointers pasted on the screen, press button 5.
5. To cancel the pointer feature, press **Esc**.

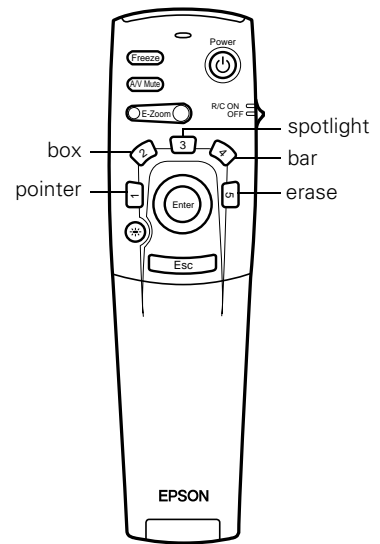

note

You can use the projector's Effect menu to select different pointers. See page 49.

Using Box Highlights

You can draw outline boxes on the screen to highlight areas of your presentation or video.

note

You can use the projector's Effect menu to change the color and shape of the box. See page 49.

1. To activate the box tool, press button **2** on the remote control. A  colored square appears in the upper left corner of the screen. This is the box-drawing tool.
2. Use the **Enter** button to place the square where you want to begin drawing the box.
3. Press down in the center of the **Enter** button. You see a corner mark on the screen; this defines one corner of the box.
4. Use the **Enter** button to drag the square to where you want the opposite corner of the box to be.
5. Press down in the center of the **Enter** button. You see the box outlined on the screen.

You can continue placing boxes on the screen by repeating steps 2 through 5.

6. To erase the box(es), press button **5**.
7. To cancel the box drawing feature, press **Esc**.

Spotlighting Your Image

With the Spotlight tool, you can highlight part of the screen.

1. To activate the spotlight tool, press button **3** on the remote control. A spotlight appears on the image.
You can continue pressing button **3** to switch between three spotlight sizes.
2. Use the **Enter** button to move the spotlight where you want it.
3. To remove the spotlight, press **Esc**.

You can change the default size of the spotlight using the Effect menu; see page 49.



Using Horizontal and Vertical Highlights

With the bar tool, you can draw bold horizontal or vertical lines on the screen to underline or highlight your presentation points. You can choose from three types of bars.

1. To activate the bar tool, press button **4** on the remote control. A horizontal bar appears across the screen. If you want a vertical bar, press **4** again. If you want to try another horizontal bar, press **4** again.
2. Use the **Enter** button to move the bar up and down the screen (or left and right if you are using the vertical bar).
3. To cancel the bar drawing feature, press **Esc**.

note

You can change the color and width of the bars using the Effect menu. See page 49.

Using the Remote Control as a Wireless Mouse

When you use the remote control as a wireless mouse, you can control your computer or click through slideshow-style presentations (such as PowerPoint) from up to 30 feet away. This gives you more flexibility, since you won't need to stand near your computer to change slides, for example.

First make sure you have connected the mouse cable between the projector and your computer as described on page 13 (for laptops) or in Appendix A (for other systems). Note that your computer's mouse may be disabled when you connect the projector's mouse cable. If you have a laptop, you won't be able to use an external mouse; however, you may still be able to use the computer's built-in mouse pointer.

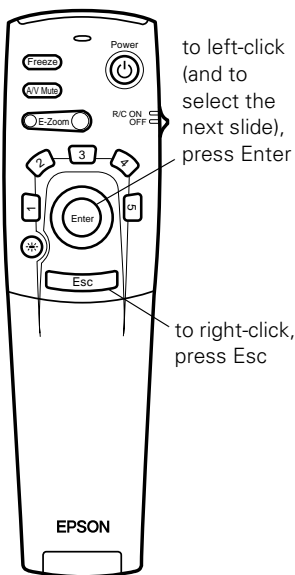

- To move the mouse pointer on the screen, aim the remote at the screen and press on the edge of the **Enter** button with your thumb—or grasp it between your thumb and finger and tilt it in the direction you want to move. This button works like the mouse button on many laptop keyboards.
- To click (or left-click), press down on the center of the **Enter** button. This changes slides in a PowerPoint presentation when you're in Slide Show mode.
- To right-click, press the **Esc** button.
- To double-click, press down twice on the **Enter** button.
- To click and drag, press down on the **Enter** button and then tilt it in the direction you want to drag.

4 *Fine-tuning the Projector*

You can use the projector's on-screen menus to adjust the image, sound, and other features. You can also create your own startup screen, customize the highlighting tools, and find out how long your lamp has been in use. This chapter covers the following information:

- Using the menu system
- Adjusting the image
- Adjusting the sound
- Customizing the highlighting controls
- Creating your own startup screen
- Customizing projector features
- Viewing lamp usage and other information
- Restoring the default settings

Using the Projector's Menu System

The eight projector menus let you adjust and customize the projector features from either the control panel or remote control:

- The Video menu controls the look and quality of the projected image. It lets you adjust the image position and fine-tune settings such as Brightness, Sharpness, and Contrast.
- The Audio menu controls the volume level, treble, and bass settings.
- The Effect menu lets you change the cursor speed and modify the highlighting tools available on the remote control.
- The Setting menu allows you to set or adjust features such as the Picture in Picture (P in P) video source, blank screen color, A/V Mute display option, and sleep mode.
- The User's Logo menu lets you capture and store a custom image or logo which you can then use as a startup screen or with the A/V Mute option.
- The Advanced menu lets you specify additional projector settings, including menu language, startup screen, color setting, and rear or ceiling projection.
- The About menu provides information about lamp status and computer or video settings.
- The Reset All menu lets you restore the factory defaults for all the projector settings.

Changing Menu Settings

You can use the buttons on the control panel or remote control to access the menus and change settings. Follow these steps:

1. To display the menu screen, press the **Menu** button on the control panel or the remote control.

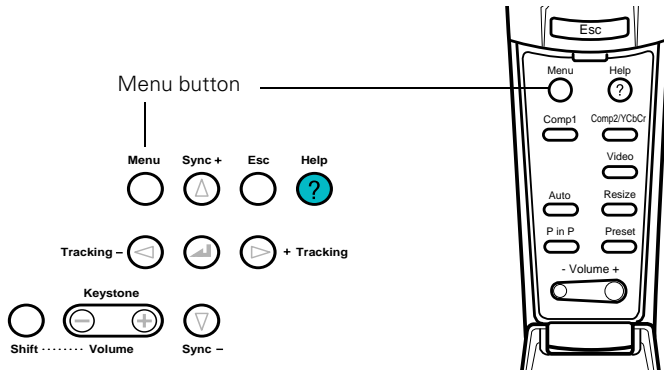

You see the menu screen:

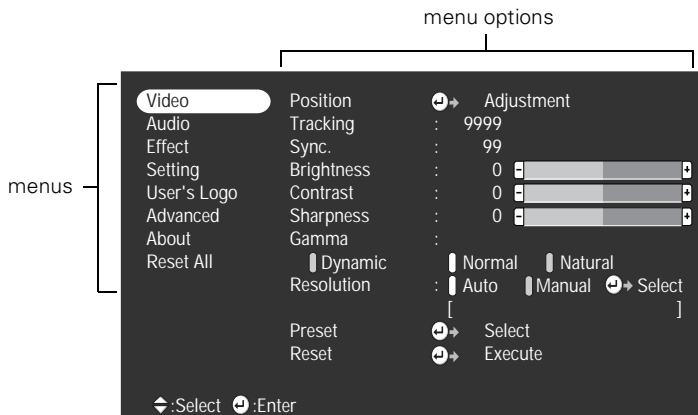

The eight menus are listed on the left, and the options available for the highlighted menu are shown on the right.

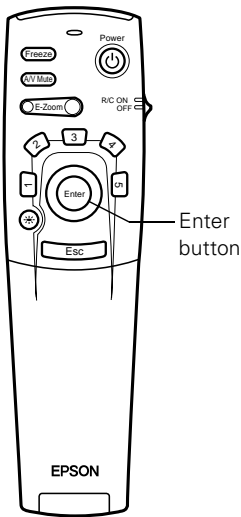

2. Press the ▲ up or ▼ down arrows on the control panel, or press up or down on the **Enter** button on the remote control, to scroll through the menu list.

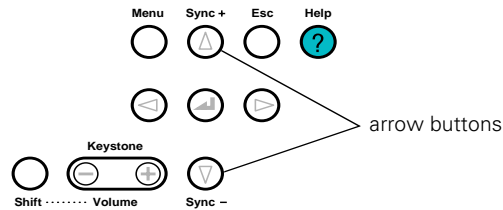

3. When the menu you want is highlighted, press the ← button (control panel) or the **Enter** button (remote control) to select it. The highlight moves to the first option for that menu.
4. Use the arrow buttons (control panel) or the **Enter** button (remote control) to scroll through the list of options. (If a computer or video source isn't connected, certain options may be unavailable.)
5. Use the arrow buttons (control panel) or the **Enter** button (remote control) to change the setting for the selected option. Enabled settings are indicated by a green light, while disabled ones are blank.
6. Press the **Esc** button to return to the main menu. Your changes are saved automatically.
7. Press **Esc** again (or the **Menu** button) to exit the menu system.

note

*If you want to go back to the default settings on any menu, select **Reset**, press **Enter**, select **Yes**, and then press **Enter**.*

Adjusting the Image

The Video menu lets you make adjustments to the projected image. The options available in the menu depend on which source is connected to the projector: standard computer video, DVI (digital) computer video, composite or S-Video, or component video.

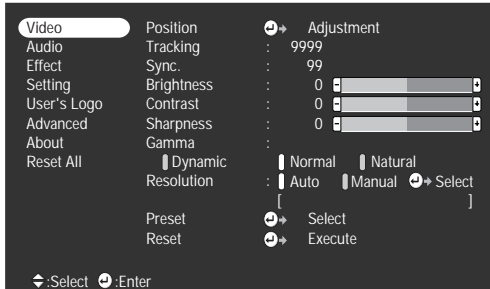

Video menu for standard computer display



Video menu for DVI computer display

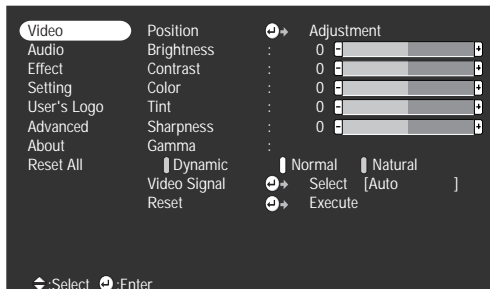

Video menu for composite video or S-Video



Video menu for component video

note

If you have repositioned the image or adjusted the sync setting, you can use the Auto button on the remote control to restore the default settings.

Repositioning the Image

Follow these steps to move the image to a different position:

1. Press the **Menu** button. You see the menu screen.
2. Press **Enter** to select the Video menu.
3. Press **Enter** to select the **Position** option. You see the following on the right side of the screen:
4. Use the arrow buttons (control panel) or the **Enter** button (remote control) to move the image left, right, up, or down.
5. When the image is positioned the way you want, press **Esc** to exit the menu system.

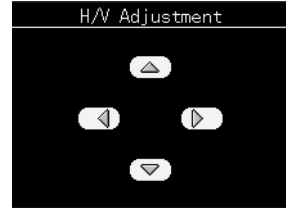

Adjusting Image Appearance

Follow these steps to adjust the appearance of your image:

1. Press the **Menu** button. You see the menu screen.
2. Press **Enter** to select the Video menu.
3. Use the arrow buttons (control panel) or the **Enter** button (remote control) to set one of the following options:
 - **Brightness**
Lightens or darkens the overall image.
 - **Contrast**
Adjusts the difference between light and dark areas.
 - **Tracking (computer images only)**
Removes unwanted vertical lines from a computer image by matching the projector's internal clock to the computer display signal.
 - **Sync (computer images only)**
Corrects fuzziness by synchronizing the projector with the tracking signal sent from the computer.
 - **Color (composite video or S-Video only)**
Adjusts the color depth or intensity of the image.

- **Tint (video only)**
Adjusts the balance of green to magenta in the image.
 - **Sharpness**
Adjusts the sharpness of the image.
 - **Gamma**
Choose **Dynamic** for computer images with bright colors (such as charts or graphs), or **Natural** to enhance video images.
 - **Resolution (computer images only)**
Leave this setting at **Auto** to allow the projector to detect the video signal automatically. If the projector is unable to sync up with the computer, select **Manual** and choose one of the settings.
 - **Video Signal**
Leave this setting at **Auto** unless you are using a 60-hertz PAL system (select **PAL60**).
4. When the image is set correctly, press **Esc**. Your settings are automatically saved.

Saving and Recalling Computer Settings

When you are projecting from a computer source, you can save and recall settings (resolution, tracking, sync signal, and position) in up to five different combinations. This is useful if you use more than one computer with the projector; you can save the settings for each one and recall them when necessary. Follow these steps to save the projector's current settings:

1. Press the **Menu** button to display the Main menu.
2. Press **Enter** to select the Video menu.
3. Use the down arrow (control panel) or **Enter** button (remote control) to move down to the **Preset** option and press **Enter**. You see the Preset Selection menu with the current resolution setting displayed.

4. Use the down arrow (control panel) or **Enter** button (remote control) to select the number to which you want to assign the current settings.
5. Press **Enter**. When you see the “Overwrite?” prompt, select **Yes** and press **Enter**.
6. Press **Esc** to exit the menu system.

When you want to use a saved setting, press the **Preset** button on the remote control. You see the setting number displayed in yellow at the top right of the screen.

To select another number, press the **Preset** button again until the setting number you want is displayed. The projector resets itself according to the selected setting.

Adjusting the Sound

You can use the Audio menu to adjust the sound volume or treble/bass balance.

1. Press the **Menu** button. You see the menu screen.
2. Press the down arrow (control panel) or press down on the **Enter** button (remote control) to highlight **Audio**. You see the following:

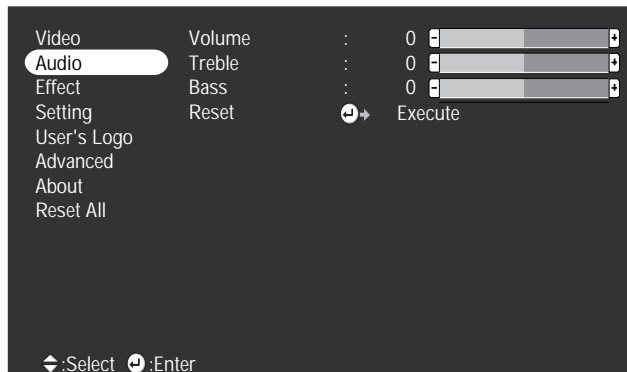

3. Press **Enter** to select the Audio menu.

4. Use the arrow buttons (control panel) or the **Enter** button (remote control) to set the following options:
 - Volume
 - Treble
 - Bass
5. When you're finished adjusting the sound, press **Esc** or **Menu**.

Customizing the Highlighting Tools

The highlighting tools let you add pointers and other types of annotations to your image, as described on pages 37 to 39. You can use the **Effect** menu to customize these tools and set the cursor speed for highlighting. The **Reset** option lets you return all the highlighting tools to their default settings.

1. Press the **Menu** button. You see the main menu.
2. Use the down arrow button (control panel) or the **Enter** button (remote control) to highlight **Effect**. You see the **Effect** menu:



3. Press **Enter** to select the **Effect** menu.

4. Use the arrow buttons (control panel) or the **Enter** button to customize:
 - **Cursor/Stamp**
Lets you define the shape and size for three different pointers. For some pointers, you can also define the color and length.
 - **Box**
Lets you define the box color and choose from a solid or outline box, with rounded or square corners.
 - **Spotlight**
Lets you choose a large, medium, or small spotlight.
 - **Bar**
Lets you define three different bars. For each one, you can set the color and width, and choose between vertical and horizontal.
5. When you're finished customizing the highlighting tools, press **Esc**. Your selections are saved.

Creating Your Own Startup Screen

You can transfer any image from your computer or video source to the projector, and then use it as your startup screen. You can also use it as the screen displayed when the projector is not receiving a signal or when you press the **A/V Mute** button. The image can be a company logo, slogan, photograph, or any other image you want to use.

Capturing the Image

Start by displaying the image you want to use. It can be an image from either a computer or video source such as a DVD player or digital camera. Then follow these steps to capture the image and transfer it to the projector:

1. Press the **Menu** button on the control panel or remote control. You see the menu screen.
2. Press the down arrow (control panel) or press down on the **Enter** button (remote control) to highlight the **User's Logo** menu, then press **Enter**.

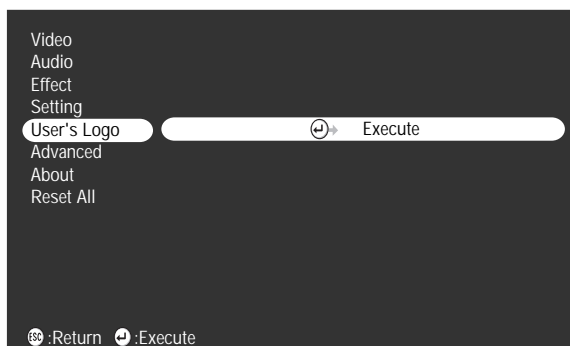

3. When you see the screen shown at right, select **Yes** and press **Enter**. A selection box displays over the image.
4. Use the arrow buttons on the control panel or the **Enter** button on the remote control to select the area of the image you want to use. Then press **Enter**.
5. When you see the message “Do you use this image?” select **Yes** and press **Enter**.



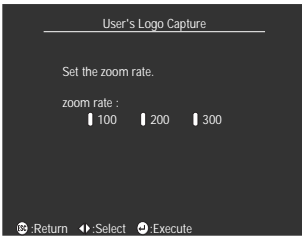

You see the screen shown at the left.

6. Use the arrow buttons on the control panel or the **Enter** button on the remote control to select a zoom rate (display size), and then press **Enter**.
7. When the message “Do you save the user’s logo?” appears, select **Yes** and press **Enter**.

Saving the logo may take a few moments. Do not use your projector or video source (computer, DVD player, etc.) while the logo is being saved.

8. When you see the message “Saving the user’s logo is completed,” press **Esc** to return to the menu screen.

Choosing When to Display the Image

After your image is saved, you can set it up as the no-signal message and/or the screen that’s displayed when you press the **A/V Mute** button.

1. Press the **Menu** button to display the menu screen (if not already displayed).
2. Press the down arrow (control panel) or press down on the **Enter** button (remote control) to highlight the **Setting** menu.
3. Press the **Enter** button to select the Setting menu.
4. Press the down arrow (control panel) or press down on the **Enter** button (remote control) to highlight either **No-Signal Msg.** or **A/V Mute**, depending on when you want the image to display.
5. Press the right arrow or use the **Enter** button to select **Logo**. This sets your image as the screen to be displayed.
6. When you’re finished, press **Esc** to exit the menu system.

note

You can also set up your image as the startup screen using the Advanced menu; see page 54.

Customizing Projector Features

You can use the Setting menu to disable the projector's sleep mode, adjust the image shape, and customize several other features.

1. Press the **Menu** button.
2. Use the arrow keys (control panel) or the **Enter** button (remote control) to highlight **Setting**. You see the options and their settings on the right side:

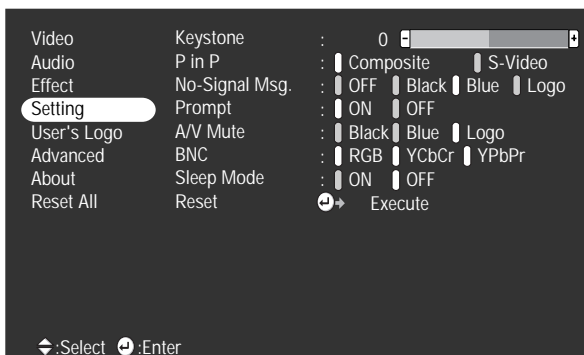

3. Press **Enter** to select the Setting menu.
4. Use the arrow buttons (control panel) or the **Enter** button (remote control) to set the following options:
 - **Keystone**
Corrects the shape of an image that's no longer square after raising the projector.
 - **P in P**
Selects the source used by the picture-in-picture display (standard composite video or S-Video).
 - **No-Signal Msg.**
Selects a screen color or image to display when the projector is not receiving a signal. The logo setting displays an image that you have transferred to the projector (see page 51).
 - **Prompt**
Turns off the identifying text that appears briefly when you switch picture sources. (It's best to leave this on.)

- **A/V Mute**
Selects the screen color or image to display when you press the **A/V Mute** button. The logo setting displays an image that you have transferred to the projector (see page 51).
- **BNC**
Specifies the format for input to the **Computer 2/Component Video** port. If the source is a computer, select **RGB**. If the source is a video device, select **YCbCr** or **YPbPr**.
- **Sleep mode**
When sleep mode is on, the projector turns off the lamp if it has not received any input signals for 30 minutes. Turn sleep mode off if you want the lamp to remain on all the time.

5. When you're finished, press **Esc**.

Setting Advanced Features

You can use the Advanced menu to configure the projector for rear projection or ceiling mounting, and adjust several other features.

1. Press the **Menu** button.
2. Use the arrow keys (control panel) or the **Enter** button (remote control) to highlight **Advanced**. You see the features and their settings on the right side:

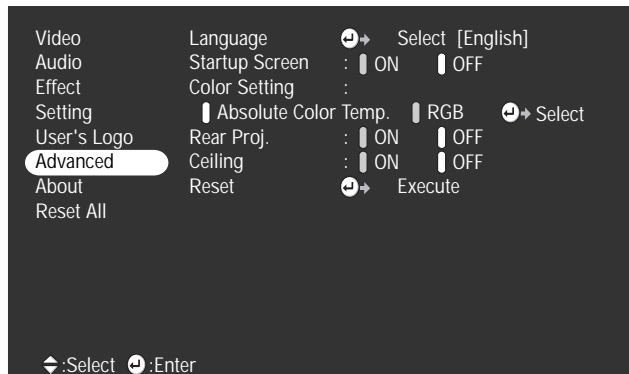

3. Press **Enter** to select the Advanced menu.

4. Use the arrow buttons (control panel) or the **Enter** button (remote control) to set the following options:
 - **Language**
Select from 9 languages to be used for the projector menus.
 - **Startup Screen**
Turn on to display your captured image or logo whenever the projector starts. (See page 51 for more information.)
 - **Color Setting**
Adjusts the color temperature of the projected image. Select **Absolute Color Temp.** to set a temperature between 5000 and 10000 K. Select **RGB** to adjust individual red, green, and blue values, as shown.
 - **Rear Proj.**
Turn on to project from behind onto a transparent screen.
 - **Ceiling**
Turn on when the projector is mounted upside-down from the ceiling.
5. When you're finished, press **Esc**.

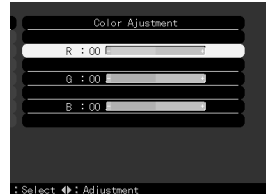

Viewing Lamp Usage and Other Information

Use the About menu to view information about the display settings of your computer and the number of hours the lamp has been used.

1. Press the **Menu** button. You see the main menu.
2. Use the arrow buttons (control panel) or the **Enter** button (remote control) to select **About**.

note

If you access the About menu when the projector display is set to video, you see only the lamp life and the video signal setting.

You see the lamp usage hours and computer display settings on the right:

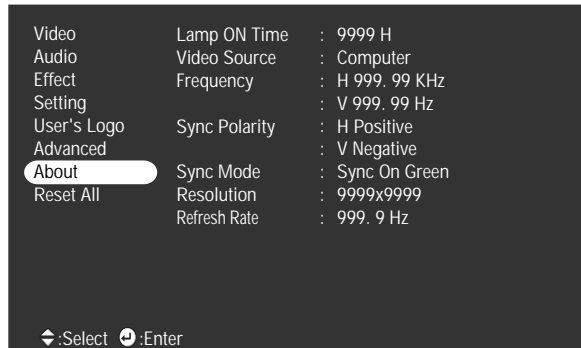

note

The lamp usage timer doesn't register until you've used the lamp for at least 10 hours.

The life span of the lamp is about 1500 hours. If the number shown is close to 1500, make sure you have a spare lamp handy.

3. When you're finished, press Esc.

Restoring the Default Settings

The Reset All option lets you return all the projector settings to their default values.

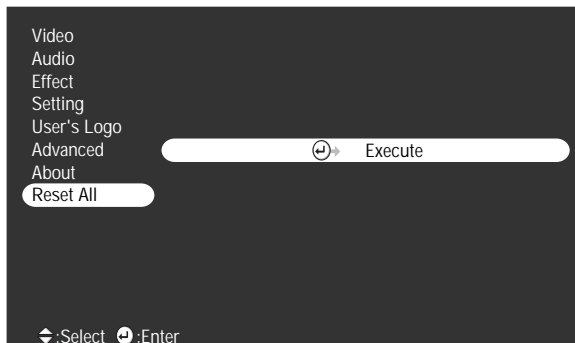

Select **Reset All** and press the Enter button on the control panel or remote control to display the confirmation screen. Select **Yes** to reset all the default settings or **No** to cancel.

5 *Maintaining and Transporting the Projector*

warning

Before you clean any part of the projector, turn it off and unplug the power cord. Never open any cover on the projector, except the lamp and filter covers. Dangerous electrical voltages in the projector can injure you severely. Do not try to service this product yourself, except as specifically explained in this User's Guide. Refer all other servicing to qualified service personnel.

Your projector needs little maintenance. All you need to do on a regular basis is keep the lens clean. Any dirt or smears on the lens may show up on your projected image.

You also need to periodically clean the air filter on the bottom of the projector. A clogged air filter can block ventilation needed to cool the projector and keep it from overheating.

The only parts you should replace are the lamp and air filter. If any other part needs replacing, contact your dealer or a qualified service person.

This chapter covers the following:

- Cleaning the lens
- Cleaning the projector case
- Cleaning and replacing the air filter
- Replacing the lamp
- Transporting the projector

Cleaning the Lens

Clean the lens whenever you notice dirt or dust on the surface.

- Use a canister of compressed air to remove dust.
- To remove dirt or smears on the lens, use lens-cleaning paper. If necessary, moisten a soft cloth with lens cleaner and gently wipe the lens surface.

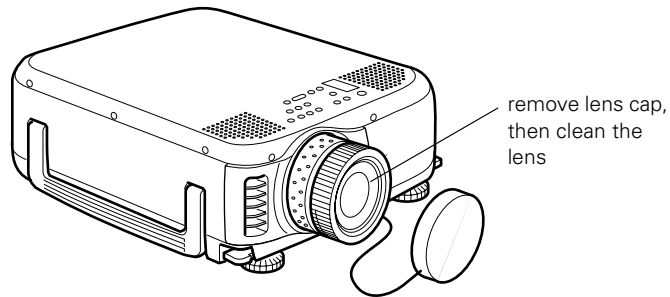

Cleaning the Projector Case

Before you clean the case, first turn off the projector and unplug the power cord.

- To remove dirt or dust, wipe the case with a soft, dry, lint-free cloth.
- To remove stubborn dirt or stains, moisten a soft cloth with water and a neutral detergent. Then wipe the case.
- Do not use alcohol, benzene, thinner, or other chemical detergents. These can damage the case.

Cleaning and Replacing the Air Filter

Clean the air filter at the bottom of the projector after every 100 hours of use. If it is not cleaned periodically, it can become clogged with dust, preventing proper ventilation. This can cause overheating and damage the projector. To clean the air filter, follow these steps:

1. Turn off the projector, allow it to cool down, and unplug the power cord.
2. Turn the projector on its side so that the handle is on top and you can access the filter easily.
3. To clean the filter, EPSON recommends using a small vacuum cleaner designed for computers and other office equipment. If you don't have one, gently clean the filter using a very soft brush (such as an artist's camel-hair brush).

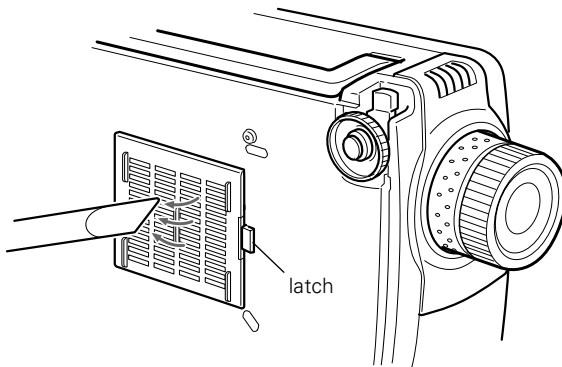

4. If the dirt is difficult to remove or if the filter is torn, replace it. Contact your dealer or call EPSON at (800) 873-7766 in the United States and Canada to obtain a new one.

Before removing the filter, make sure the projector is on its side as shown (not upside down) to prevent dust from falling inside. Then release the latch to remove the filter.

note

When you get a replacement lamp for your projector, a new air filter is included. You should replace the filter when you replace the lamp.

5. To install the new filter, first insert its tabs as shown, then press on the latch until it clicks in place.

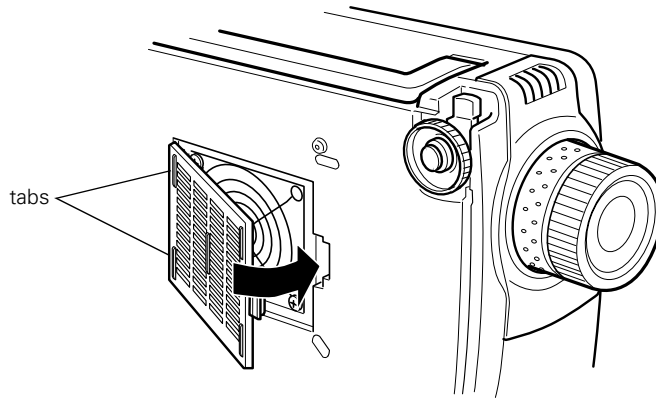

Replacing the Lamp

note

You can check to see how many hours the lamp has been used. See page 55.

The projection lamp typically lasts for about 1500 hours of use. It is time to replace the lamp when:

- The projection image gets darker or starts to deteriorate.
- The lamp warning light  is flashing red or orange.
- The message **LAMP REPLACE** appears on the screen when the projector lamp comes on (after about 1400 hours of use). To maintain projector brightness and image quality, replace the lamp as soon as possible.

Contact your dealer or call EPSON at (800) 873-7766 in the United States and Canada for a replacement lamp. Request part number ELPLP12.

Follow these steps to replace the lamp:

1. Turn off the projector and unplug the power cord.
2. Allow the projector to cool down for at least an hour (if it has been on).
3. Use a screwdriver to loosen the retaining screw on the lamp cover. (You can't remove the screw from the cover.)

When the screw is loose, slide off the lamp cover.

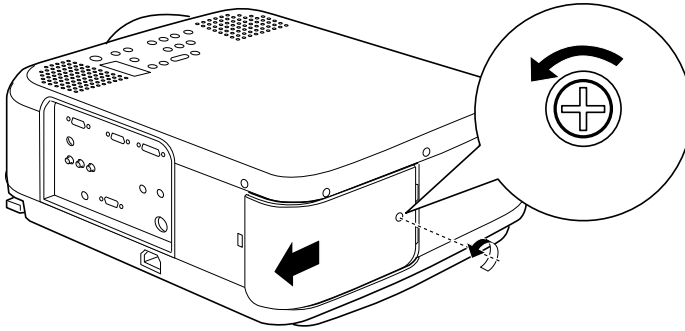

4. Use a screwdriver to loosen the two screws holding the lamp in place. (You can't remove these screws.)
5. Lift up the wire handle, as shown, and pull the lamp straight out.

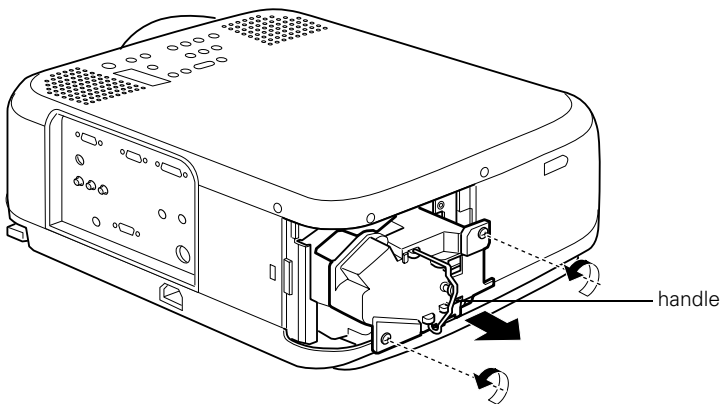

warning

Let the lamp cool before replacing it. If the lamp breaks, handle the shards carefully to avoid injury.

caution

Do not touch the glass portion of the lamp assembly. Touching the glass could result in premature lamp failure.

6. Insert the new lamp as shown.

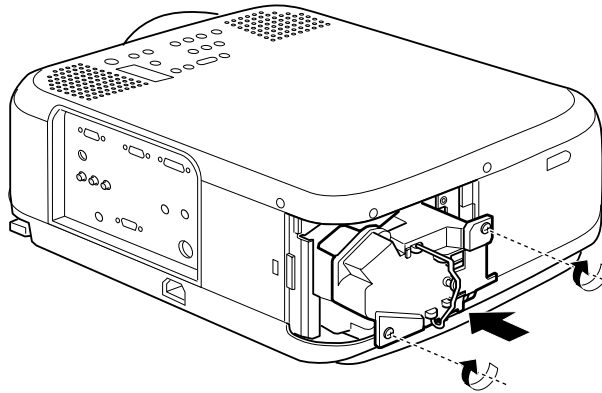

7. Make sure the lamp is fully seated, then tighten its screws.
8. Replace the lamp cover and tighten its screw securely. (The projector won't come on if the lamp cover is loose.)
9. Reset the lamp timer as described in the following section.

Resetting the Lamp Timer

After installing a new lamp, you need to reset the timer so the projector can keep track of how many hours it has been used. Follow these steps:

1. Plug in the projector and turn it on (see page 22).
2. After the projection lamp comes on, press the **Help** button and hold it down for at least 5 seconds.

You see the Help menu, and then the following message:



3. Use the left arrow button (control panel) or press left on the **Enter** button (remote control) to select **Yes**.
4. Press **Enter** to reset the timer.

Transporting the Projector

The projector contains many glass and precision parts. If you need to transport it, please follow these packing guidelines to prevent damage to the projector:

- When shipping the projector for repairs, use the original packaging material if possible. If you do not have the original packaging, use equivalent materials, placing plenty of cushioning around the projector.
- When transporting the projector for business use, first put it in a hard-shell carrying case (such as an optional EPSON case), then pack it in a firm box, using cushioning around the case.
- When hand-carrying the projector, store it in a carrying case, such as one of the optional cases offered by EPSON.

If you want to store the remote control inside the projector's carrying case, be sure to turn it off using the switch on its side. This prevents the batteries from discharging if something inside the case presses against one of the remote control's buttons.

note

EPSON shall not be liable for any damages incurred during transportation.

6 *Solving Problems*

This chapter helps you solve problems with your projector, and tells you how to contact technical support for problems you can't solve yourself. This chapter explains the following:

warning

Except as specifically explained in this User's Guide, do not attempt to service this product yourself.

- Using the projector's on-screen help system
- What to do when the projector's status lights flash
- Solving problems with the image or sound
- Solving problems with the remote control
- Contacting technical support

Using On-Screen Help

If you see a **No Signal** message or your audio isn't working, you can get help by pressing the blue **? Help** button on top of the projector or under the cover on the remote control. The following choices are available:

- **Help for the image**
Tells you what to do if you see a **No Signal** message
- **Help for the sound**
Tells you what to do when your audio isn't working
- **Language selection**
Lets you display the help information and projector menus in any of nine different languages

Follow these steps to get help:

1. Press the blue **? Help** button. You see the help menu.
2. Use the **▲** up or **▼** down arrow buttons on the control panel (or move the **Enter** button up or down on the remote control) to highlight one of the options. Then press the **↵** or **Enter** button to select it.
3. Press the **↵** or **Enter** button again to view the solutions. (Press **Esc** if you need to back up.)
4. Press the down arrow button on the control panel (or press down on the **Enter** button on the remote control) to display additional text.
5. To exit the Help system, press the blue **? Help** button.

If none of the suggestions solves your problem, see additional solutions to problems in the following sections.

caution

*Don't hold the **? Help** button for more than 5 seconds, or the projector will enter the mode for resetting the lamp timer.*

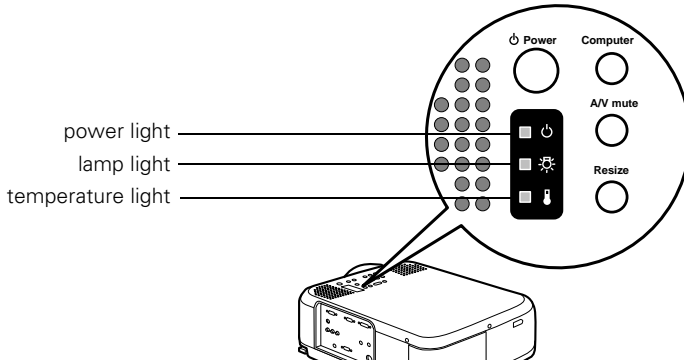

What To Do When the Lights Flash

The lights on top of the projector indicate the projector's status and let you know when a problem occurs.



If the projector is not working correctly, first turn it off and unplug it. Then plug the power cord back in and turn on the projector. If this does not solve the problem, check the status lights on top of the projector and try the solutions recommended below.

Light	Status	Description
⏻	does not come on	Make sure the power cord is securely connected both at the power outlet and the projector.
⏻	green	The projector is operating normally.
⏻	flashing green	The projector is warming up. Wait for the image to appear.
⏻	orange	The projector is in sleep mode. You can unplug it to turn it off or press the Power button to turn it on.
⏻	flashing orange	The lamp is cooling down. Don't unplug the projector until the light stops flashing and remains orange. If you want to turn the projector back on, wait until the light stops flashing and press the Power button.
⏻	flashing red	Power is cut off because of an internal problem. Remove the power cord and contact EPSON for help; see page 75.
💡	flashing orange	The lamp is almost burned out. This is a good time to replace it. See page 60 for instructions.
💡	flashing red	The lamp is burned out. Replace it as described on page 60. If you have just replaced the lamp, make sure its cover is fastened securely.

Light	Status	Description
	flashing orange	The projector is getting too hot. Turn it off and let it cool. Make sure the temperature surrounding the projector does not exceed 104 °F and there is plenty of space around and under the projector for ventilation. You should also check the air filter; if necessary, clean or replace it as described on page 59.
	red	The projector has overheated and turned itself off. Let it cool for a few minutes, then turn it back on. Make sure there is plenty of space around and under the projector for ventilation. If necessary, clean or replace the air filter as described on page 59. If the projector continues to overheat, the problem may be caused by damage to the cooling fan or internal circuits. Contact EPSON for help; see page 75.
	flashing red	There is a problem with the cooling fan or temperature sensor. Turn off the projector and unplug it. Contact EPSON for help; see page 75.

Solving Problems with the Image or Sound



No image appears on the screen.

- Check that the power light is green, not flashing, and the lens cover is off.
- The projector may be in sleep mode. If the power light is orange, press the **Power** button to turn the projector on.
- If the power was switched off and then on again, the projector may still be cooling down. Wait until the power light stops flashing and remains orange; then press the **Power** button again.
- Make sure the **Brightness** setting on the Video menu is correct. See page 45 for more information. Try selecting the **Reset All** setting to return all setup menus to their default values.
- Press the **A/V Mute** button to make sure the picture has not been turned off temporarily.
- The attached computer may be in sleep mode or displaying a black screen saver. Try pressing a key on the computer.

You see a blue screen with the message No Signal displayed.

- Make sure the cables are connected correctly, as described in Chapter 1 or Appendix A.
- Try restarting your computer.
- If you've connected more than one computer and/or video source, you may need to press the **Computer** or **Video** button (on the control panel) or the **Comp1**, **Comp2/YCbCr**, or **Video** button (on the remote control) to select the correct source. Allow a few seconds for the projector to sync up after pressing the button.
- Make sure the **Computer 1** selector switch on the projector's interface panel is set to **Analog** (for standard computer video) or **Digital** (for a computer using DVI video). See page 12.

If you're using a PC laptop:

- Hold down the **Fn** key and press the function key that lets you display on an external monitor. It's often labelled with an icon such as  or it may be labelled **CRT/LCD**. Check your laptop's manual or online help for details. On most systems, the  key lets you toggle between the LCD screen and the projector, or to display on both at the same time. Allow a few seconds for the projector to sync up after pressing it.
- Depending on your computer's video card, you might need to use the Display utility in the Control Panel to make sure that both the LCD screen and external monitor port are enabled. See your computer's documentation or online help for details.

If you're using a PowerBook:

1. From the Apple menu, select **Control Panels**, then click **Monitors and Sound**.
2. Click the **Arrange** icon.
3. Drag one monitor icon on top of the other. This lets you display on the projector screen as well as the LCD screen.
4. If the **Arrange** option isn't available, click the **Monitor** icon.
5. Select one of the listed **Simulscan** resolutions. (It may take a moment for the projector to sync up.)

The message Not Supported is displayed.

- If you've connected a second computer or you're using component video, make sure the **BNC** option in the Setting menu is correct. See page 54.
- Make sure your computer's resolution doesn't exceed UXGA (1600 × 1200), and the frequency is supported by the projector (see page 97). If necessary, change your computer's resolution setting as described below.

Only part of the computer image is displayed.

- Press the **Resize** button on the control panel or remote control.
- Make sure the image **Position** setting is correct on the Video menu. See page 46 for more information.
- If you've connected a second computer, make sure the **BNC** option in the Setting menu is set to **RGB**. See page 54.
- Make sure your computer's resolution setting is correct. Ideally, it should be 1024 × 768 (for the PowerLite 7600p) or 800 × 600 (for the PowerLite 5600p) to match the projector's native resolution. If this option isn't available, select one of the other compatible video formats listed on page 97.
 - **Windows:**
Right-click the desktop, select **Properties**, click the **Settings** tab, and use the dialog box to select a different resolution.
 - **Macintosh:**
On the Apple menu, choose **Control Panels**, then click **Monitors and Sound**. Select a different resolution.
- You also may need to modify existing presentation files if you created them for a different resolution. See your software documentation for specific information.

The image isn't square, but trapezoid-shaped.

- Make sure the projector isn't placed off to one side of the screen, at an angle. Place the projector directly in front of the center of the screen, facing the screen squarely.
- If you've tilted the projector upward by extending the legs, the image will be broader at the top. Hold down the + or - side of the **Keystone** button on top of the projector until the image is square.

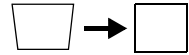
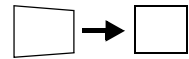

The image contains static or noise.

- If you've connected a second computer or you're using component video, make sure the **BNC** option in the Setting menu is correct. See page 54.
- If you're using a computer cable longer than 6 feet, the image quality may be reduced.
- Keep your computer and video cables separated from the power cord as much as possible to prevent interference.
- The video signal may be split between the computer and the projector. If you notice a decline in the projected image quality when the image is displayed simultaneously on your laptop computer and the projector, turn off the laptop's LCD display.

The image is blurry.

- There may be dirt or smears on the lens. Clean the lens as described on page 58.
- Adjust the focus using the focus ring.
- Adjust the **Sharpness** setting in the Video menu (see page 46). If you're projecting from a computer, you may also need to adjust the **Tracking** and **Sync** as described in the next section. If you don't like the new settings, you can always select **Reset** to return to the factory default settings.

You see vertical stripes or the image still looks blurry after trying the solutions in the previous section.

- If you're projecting from a computer and displaying an image that contains a lot of fine detail (such as the body of a letter), you may notice one or more vertical stripes or bands, or some of the characters may look heavy or blurred. Press **Auto** on the remote control or the **↵ Enter** button on the control panel. This resets the projector's tracking and sync settings.
- If further adjustment is needed, you can fine-tune the **Tracking** and **Sync** settings manually using the buttons on the control panel (or using the Video menu as described on page 46):
 1. Fill the screen with an image containing fine detail when making these adjustments. For example, in Windows you can click **Start**, **Settings**, and **Control Panel**, then double-click **Display**; select a pattern to appear as your desktop background. If this option isn't available, try projecting black text on a white background (such as a letter).
 2. Press the **Tracking -** and **Tracking +** buttons to eliminate vertical stripes.

note

The tracking and sync settings match the projector's internal clock to the computer's display signal. If you use the projector with different computers, you can save the projector's settings for each computer and recall them whenever needed using the Preset option. See page 47.

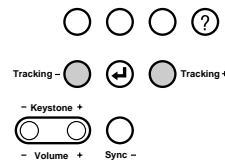
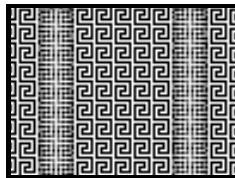

(If you don't see any changes on screen while pressing the buttons, select **Reset All** in the projector's menu system as described on page 56; then repeat the tracking adjustment.)

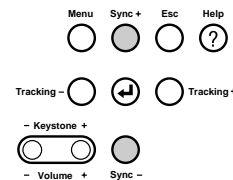
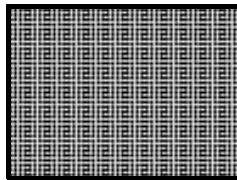

3. Press the **Sync -** and **Sync +** buttons to increase the sharpness of the image.



The colors of the image are not right.

- The color balance may be incorrect. If you're displaying a computer image, use the **Gamma** option in the projector's Video menu to adjust the balance of red, green, and blue. If you're displaying video, adjust the **Color**, **Tint**, and **Gamma** settings on the Video menu. Also try adjusting the **Color Setting** option in the Advanced menu.
- Check your computer display settings to correct the color balance.

There is no sound.

- Try turning up the volume. Hold down the **Shift** button and press the right side of the **Volume** button (control panel) or press the right side of the **Volume** button (remote control).
- If you're using a VCR or other video source, make sure the volume is not turned all the way down or muted. Also, make sure the cables are connected correctly, as described in Chapter 1.
- If your presentation includes computer audio, make sure the volume control on your computer is not turned all the way down or muted. Make sure the audio cable is securely connected to both the projector and your computer's  headphone jack or  audio out jack. See page 14 (for laptops) or Appendix A (for other systems).
- Make sure the Windows volume controls on your computer are not turned all the way down or set to Mute. You may be able to check this by right-clicking the sound icon on your Windows desktop.
- Make sure the **A/V Mute** button is not enabled.
- The wrong source may be selected. Press the **Computer** or **Video** button on the control panel—or the **Comp1**, **Comp2/YCbCr**, or **Video** button on the remote control—to select the proper source. Allow a few seconds for the projector to sync up after pressing the button.

note

Because of the different technologies used, your projected image may not exactly match the colors on your laptop or computer monitor.

Solving Problems with the Remote Control

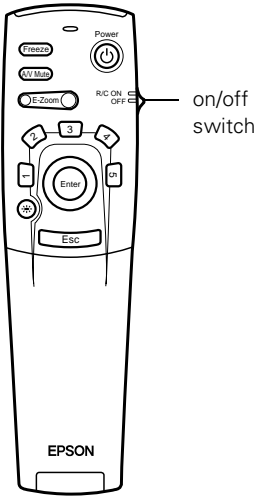

The projector doesn't respond to remote control commands.

- Make sure the remote control is turned on.
- Make sure you are within 30 feet of the projector, and within range of the projector's front or back sensor (approximately 30° to left or right and 15° above or below).
- The remote control batteries may not be installed correctly or may be low on power. To test the batteries, press the ☀ light button. The other buttons on the remote should light up temporarily. If they don't, you need to change the batteries as described on page 32.
- Dim the room lights and turn off any fluorescent lights. Make sure the projector is not in direct sunlight. Strong lighting, especially fluorescent lights, may affect the projector's infrared receivers.
- Turn off any nearby equipment that emits infrared energy, such as a radiant room heater.

You can't control the mouse pointer with the remote control.

Make sure the mouse cable is securely connected to both your computer's mouse port or USB port and the projector's mouse port. For details, see page 13 (for laptops) or Appendix A (for other systems).

Where To Get Help

EPSON provides technical assistance through electronic support services and automated telephone services 24 hours a day, as listed in the following table.

Electronic support and automated telephone services

Service	Access
World Wide Web Technical Support	From the Internet, you can reach EPSON's product support page at http://support.epson.com . After selecting your product, you can view frequently asked questions and answers, download product documentation, and receive technical advice through e-mail.
Automated Telephone Services	A variety of automated help services are available 24 hours a day, seven days a week. To use these services, you must have a touch tone telephone and call (800) 922-8911 .
Presenters Online	Access tips, templates, and training for developing successful presentations at http://www.presentersonline.com

Telephone Support Services

To use the EPSON PrivateLine Support service, call (800) 637-7661 and enter the PIN on the EPSON PrivateLine Support card included in your *Owner's Kit*. This is the fastest way of speaking to a live representative, and it's free. This service is available 6 AM to 6 PM, Pacific Time, Monday through Friday, for the duration of your warranty period.

You may also speak with a projector support specialist by dialing one of these numbers:

- U.S.: (562) 276-4394, 6 AM to 6 PM, Pacific Time, Monday through Friday
- Canada: (905) 709-3839, 6 AM to 6 PM, Pacific Time, Monday through Friday

Toll or long distance charges may apply.

Before you call, please have the following information ready:

- Product name (EPSON PowerLite 5600p or 7600p)
- Product serial number (located on the bottom of the projector)
- Video source (computer, DVD player, etc.) and how it's connected
- Description of the problem

You can purchase screens, carrying cases, and other accessories from EPSON by calling (800) 873-7766; in Canada, please call (800) 873-7766 for dealer referral. To purchase accessories online or view EPSON's complete product catalog, visit the EPSON Store[®] at www.epsonstore.com (U.S. sales only). To see our full line of multimedia projectors, go to www.epson.com/mul_proj.

A

Connecting to Additional Equipment

This appendix explains how to connect the projector to a desktop PC or Macintosh, high-end workstation, more than one computer, or a DVI video source. It also provides guidance on setting up the projector in a permanent installation.

The following information is covered:

- Installing the projector
- Connecting to a PC desktop computer
- Connecting to a desktop Macintosh
- Connecting to a second computer
- Connecting to a high-end workstation
- Connecting to a DVI video source

Installing the Projector

The projector can be installed for three different viewing setups: front projection, ceiling mounting, or rear projection onto a semi-transparent screen, as shown:

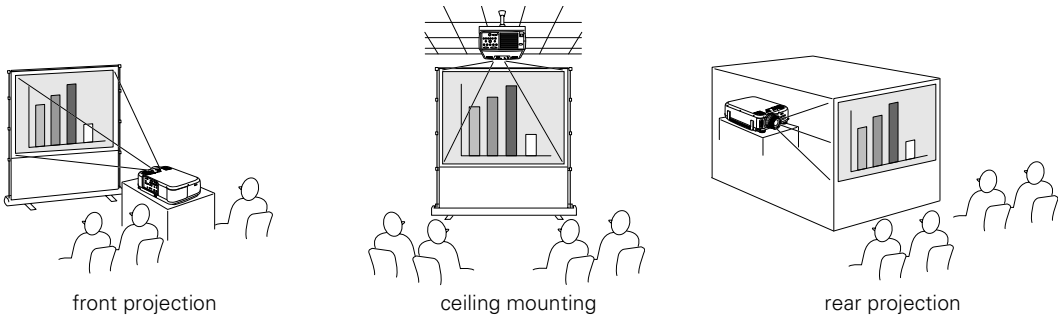

To project from overhead, you'll need to select **Ceiling** in the projector's Advanced menu. To project from the rear, select **Rear Proj.** See "Setting Advanced Features" on page 54.

If you're ceiling-mounting the projector and you place it above screen level, you'll have to tilt it down to position the image on-screen. This causes the image to lose its square shape. You can then correct the distortion by using the **Keystone** function in the projector's menu system (see "Customizing Projector Features" on page 53) or by using the **Keystone** button on the projector's control panel.

If you place the projector's lens so it's level with the top of the screen, the image will be square and you won't have to adjust it. If you place the lens lower than the top of the screen, you'll have to tilt the projector upward if you want to fill the whole screen with the image.

Controlling the Projector from a Computer

If you want to be able to control the projector's settings from a computer, you can install the EMP Link V program on the Projector Software CD-ROM. You'll also need a serial cable to connect the projector to the computer.

note

See "Positioning the Projector" on page 10 for more information.

To install EMP Link V, insert the Projector Software CD-ROM in your CD-ROM drive and follow the instructions on the screen. The installation program also installs the *EMP Link V User's Guide* on your hard disk. You can access this manual in the EMP Link V folder for complete instructions on using the program.

Connecting to an External Audio System

The projector's internal speakers are loud enough for most rooms. However, if your installation requires maximum volume and sound quality, you can connect the projector to external speakers or a public address (PA) system. This disables the projector's internal speakers.

If you've connected multiple audio and video sources to the projector, the projector will automatically switch the audio along with the video source whenever you choose a different video source. (See "Switching Between Picture Sources" on page 29 or page 34.)

To connect the projector to an external sound system, you will need an RCA-to-3.5 mm stereo audio cable, which may be included with your sound system, or may be purchased from an electronics store.

Before you start, make sure the projector and speakers or PA system are turned off.

1. Connect the cable's 3.5-mm stereo miniplug to the projector's **Audio Out** jack.

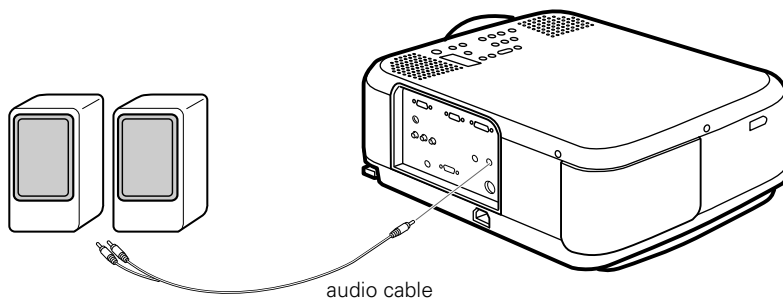

2. Connect the RCA plugs on the opposite end of the cable to the left and right jacks of your speaker or PA system.

Connecting to a PC Desktop Computer

You can connect the projector to any IBM-compatible PC. This section includes instructions for the following:

- Connecting the computer cable
- Connecting the mouse cable (if you want to use the remote control as a mouse)
- Connecting the audio cable (if you'll be projecting with audio)

Follow the steps in each section for the cables you need to connect. Before beginning, make sure the projector and computer are turned off. If you need help with positioning the projector, see page 10.

Connecting the Computer Cable

1. Disconnect the monitor cable from the video port on the back of the computer and set it aside. (You won't be able to use the monitor while the projector is connected.)
2. Connect one end of the computer cable to the projector's **Computer 1** (analog) port, as shown.

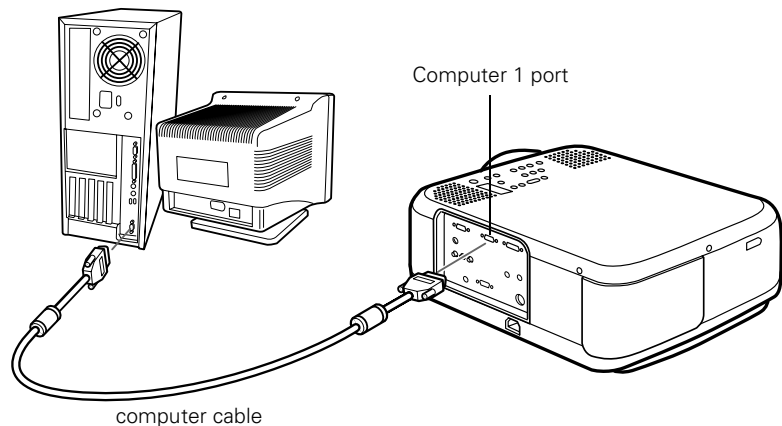

3. Connect the other end of the cable to the computer's video port.
4. Tighten the screws on the connectors.

Connecting the Mouse Cable

To use the remote control as a mouse, follow the steps below. You'll use a different mouse cable, depending on whether your computer has a round PS/2 mouse port or a flat USB port.

1. Connect the round end of the mouse cable to the projector's **Mouse port**, as shown.

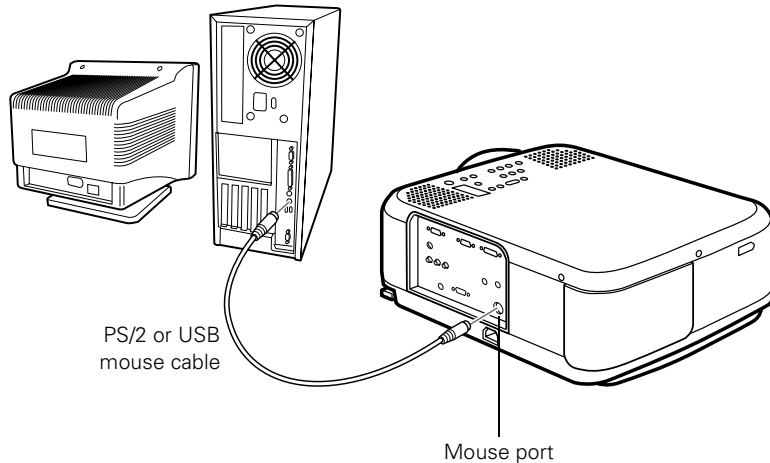

2. Disconnect your mouse from the port on the back of your computer and replace it with the other end of the cable. (Your computer's mouse will be disabled while you are using the remote control as a mouse.)

note

If you have a PC with a serial mouse port, you'll need a serial mouse cable. See your projector dealer to obtain the correct cable.

Connecting the Audio Cable

If your presentation includes sound and you want to use the projector's built-in speakers, you'll need to connect the audio cable.

1. Connect one end of the audio cable to the **Audio 1** jack on the projector.

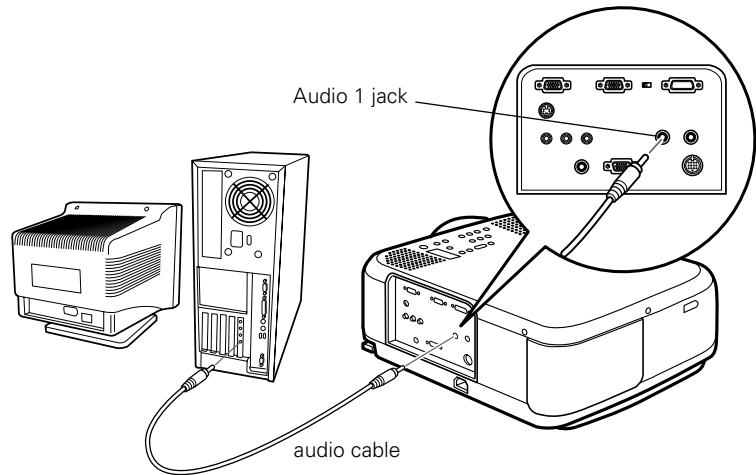

2. Connect the other end of the audio cable to the speaker or audio out port on the computer's sound card.

Connecting to a Desktop Macintosh

You can connect the projector to any desktop Macintosh. This section includes instructions for the following:

- Connecting the computer cable
- Connecting the mouse cable (if you want to use your remote control as a mouse)
- Connecting the audio cable (if you'll be projecting with audio)

Follow the steps in each section for the cables you need to connect. Before beginning, make sure the projector and computer are turned off. If you need help with positioning the projector, see page 10.

Connecting the Computer Cable

1. Disconnect the monitor cable from the video port on the back of the Macintosh and set it aside. (You won't be able to use the monitor while the projector is connected.)
2. Connect one end of the computer cable to the projector's **Computer 1** port, as shown.

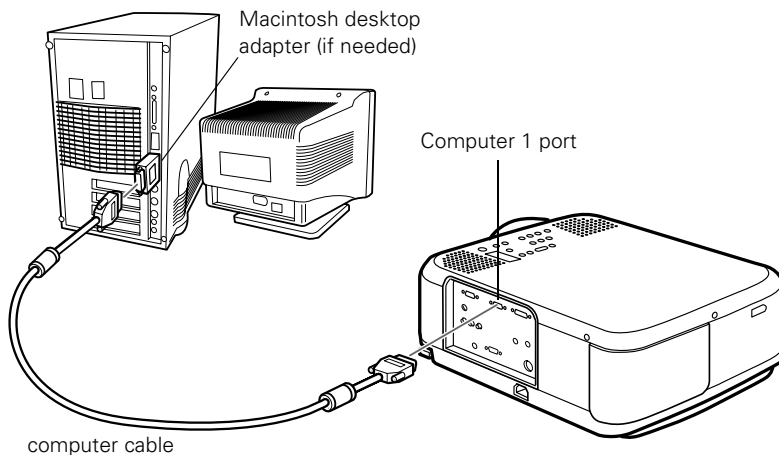

3. Connect the other end of the computer cable to the video port on the Macintosh. If it doesn't fit, you may have to use a Macintosh desktop adapter, which you can buy from EPSON (see page 8).

note

Macintosh configurations vary. See your computer manual for the location of the ports needed to connect your projector. Older models may require a Macintosh adapter set, which you may purchase from EPSON; see page 8.

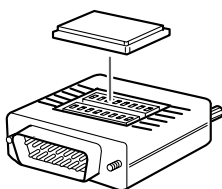

To use the adapter, remove its cover as shown and set its DIP switches according to the resolution you want to use, such as 16-inch mode. See your Macintosh documentation for instructions.

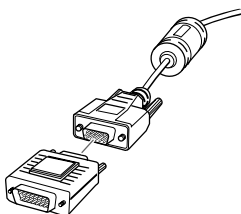

Replace the cover and connect the adapter to the free end of the computer video cable. Then plug the cable (with the adapter) into the video port on your Macintosh.

4. Tighten the screws on the connectors.

Connecting the Mouse Cable

To use the remote control as a mouse follow the steps below. If the Macintosh has a USB port, you can use the USB mouse cable included with the projector. If it has a round mouse port, you'll need a Macintosh mouse cable; see your projector dealer for help in obtaining the correct cable.

1. Connect the round end of the USB mouse cable (or a Macintosh mouse cable) to the projector's **Mouse** port.

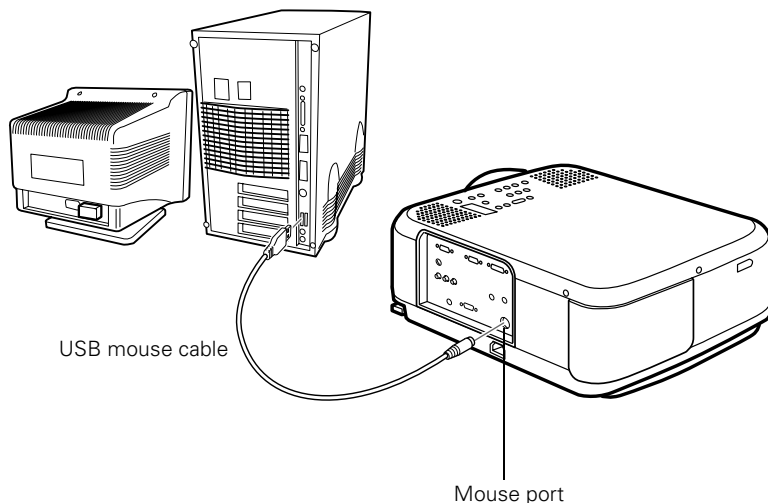

2. Disconnect your Macintosh's mouse cable. Connect the other end of the projector's mouse cable to the mouse or USB port on your Macintosh.

Connecting the Audio Cable

If your presentation includes sound and you want to use the projector's built-in speakers, you'll need to connect the audio cable.

1. Connect one end of the audio cable to the Audio 1 port on the projector.

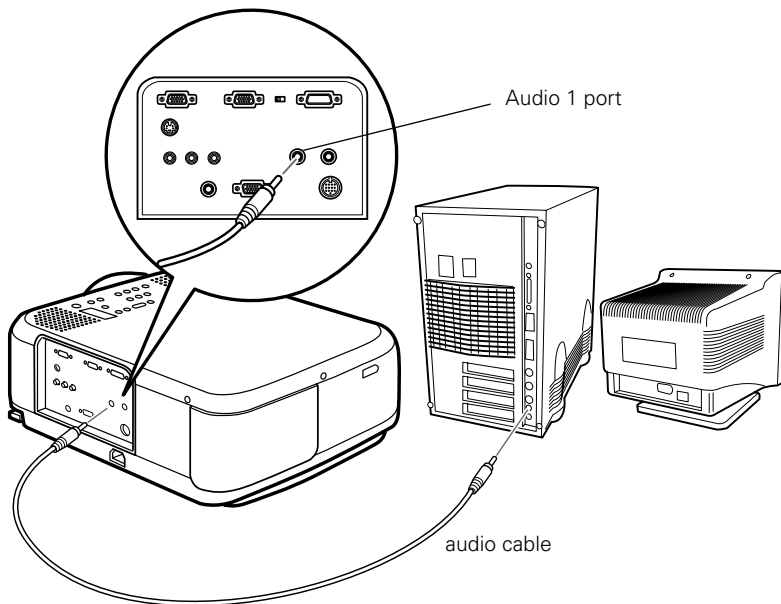

2. Connect the other end of the audio cable to the speaker or audio-out port on the Macintosh.

Connecting to a Second Computer

To connect a second computer to the projector, you need to use the projector's **Computer 2/Component Video** port. You'll also need an additional VGA (D-sub 15-pin) cable, like the one that came with your projector. You can purchase this from your computer or electronics dealer.

Follow these steps:

1. Connect one end of the cable to the computer's video port.
2. Connect the other end to the projector's **Computer 2/Component Video** port as shown.

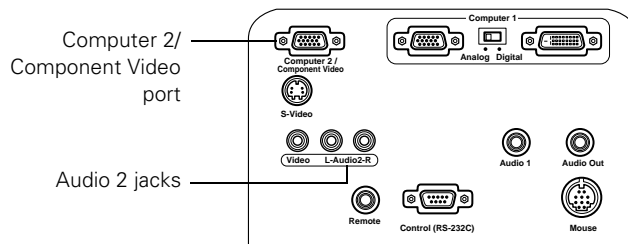

3. To display images properly, make sure the BNC option in the projector's Setting menu is set to RGB. See page 54 for instructions.
4. If you want to hear the computer's audio through the projector, you'll need an RCA-to-3.5 mm stereo cable (available for purchase from your electronics store or video dealer).

Insert the cable's 3.5-mm plug into your computer's audio-out port. Then attach the connectors at the other end of the cable to the projector's **Audio 2 jacks**, matching the white plug to the **L** jack and the red plug to the **R** jack.

Connecting to a High-End Workstation

There is no across-the-board standard for workstation video output. However, your PowerLite projector is capable of remapping input resolutions up to 1600 × 1200 pixels. Workstations that follow the SXGA standard and use the HD15 (standard VGA) connector won't need an adapter cable or any special connection device. If your system varies, contact your computer dealer for help in connecting your workstation.

Connecting to a DVI Video Source

The projector's Digital Visual Interface (DVI) receives pictures directly from your computer in digital format. This lets the projector display images of greater clarity than can be achieved using a standard analog VGA connection.

To project images in digital video format, follow these steps:

1. Connect the computer's DVI cable to the projector's DVI port.

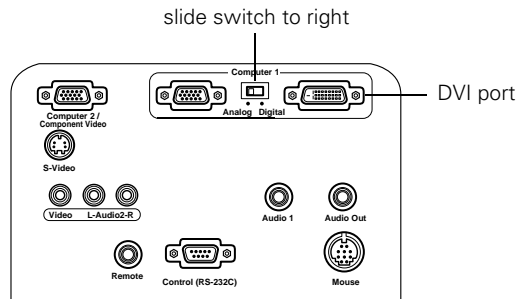

2. Using the tip of a pen or a small screwdriver, slide the **Computer 1** interface switch to the right to select **Digital**. (If you need to use the projector's VGA port again, be sure to slide the switch back to the left.)

If you want to connect audio for this computer, use the projector's **Audio 1** port; if you want to connect a mouse cable (to use the remote control as a wireless mouse), use the **Mouse** port.

B Notices

This appendix includes safety instructions and other important information about your projector.

Important Safety Instructions

Follow these safety instructions when setting up and using the projector:

- Do not place the projector on an unstable cart, stand, or table.
- Do not use the projector near water or sources of heat.
- Use attachments only as recommended.
- Use the type of power source indicated on the projector. If you are not sure of the power available, consult your dealer or power company.
- Place the projector near a wall outlet where the plug can be easily unplugged.

Placez le projecteur près d'une prise de contact où la fiche peut être débranchée facilement.

- Insert the projector's three-wire grounding-type plug into a properly grounded outlet. If you have a two-prong outlet, contact an electrician to replace it. Do not hold the plug with wet hands.
- Take the following precautions for the plug. Failure to comply with these precautions could result in sparks or fire: Do not insert the plug into an outlet with dust present. Insert the plug firmly into the outlet.
- Do not overload wall outlets, extension cords, or integral convenience receptacles. This can cause fire or electric shock.

- Do not place the projector where the cord can be walked on. This may result in fraying or damage to the plug.
- Unplug the projector from the wall outlet before cleaning. Use a damp cloth for cleaning. Do not use liquid or aerosol cleaners.
- Do not block the slots and openings in the projector case. They provide ventilation and prevent the projector from overheating. Do not operate the projector on a sofa, rug, or other soft surface, or in a closed-in cabinet unless proper ventilation is provided.
- Never push objects of any kind through cabinet slots. Never spill liquid of any kind into the projector.
- Except as specifically explained in this *User's Guide*, do not attempt to service this product yourself. Refer all servicing to qualified service personnel. Opening or removing covers may expose you to dangerous voltages and other hazards.
- Unplug the projector during lightning storms or when it will not be used for extended periods.
- Do not place the projector and remote control on top of heat-producing equipment or in a hot location.
- Unplug the projector from the wall outlet and refer servicing to qualified service personnel under the following conditions: When the power cord or plug is damaged or frayed. If liquid has been spilled into the projector, or if it has been exposed to rain or water. If it does not operate normally when you follow the operating instructions, or if it exhibits a distinct change in performance, indicating a need for service. If it has been dropped or the housing has been damaged.
- If you use the projector in a country other than where you purchased it, use the correct power cord for that country.

Remote Control Information

You can operate the projector by remote control via a line-of-sight infrared (IR) receiver at the front and rear of the projector. The projector may not respond to remote control commands under the following conditions:

- There is an object between the remote control IR emitter and the IR receiver on the projector.
- Ambient light is too bright.
- Certain types of fluorescent lighting are used.
- A strong light source shines into the IR receiver.
- Other equipment that emits infrared energy, such as a radiant room heater, is in the room.

These conditions commonly cause problems for most infrared-controlled equipment. Try the following:

- The remote control unit's batteries may be low on power; replace them.
- Dim the ambient lighting and/or turn off any fluorescent lights.
- Close any window coverings and/or move the projector out of direct sunlight.
- Turn off other equipment that emits infrared energy.

If the remote control still does not work properly, remember you can always control your computer-based presentation directly from the computer, even in an environment containing one of the conditions listed above.

Declaration of Conformity

According to 47CFR, Part 2 and 15

Class B Personal Computers and Peripherals; and/or
CPU Boards and Power Supplies used with Class B
Personal Computers

We: EPSON AMERICA, INC.
Located at: 3840 Kilroy Airport Way
MS: 6-43
Long Beach, CA 90806-2469
Telephone: (562) 290-5254

Declare under sole responsibility that the product identified herein, complies with 47CFR Part 2 and 15 of the FCC rules as a Class B digital device. Each product marketed, is identical to the representative unit tested and found to be compliant with the standards. Records maintained continue to reflect the equipment being produced can be expected to be within the variation accepted, due to quantity production and testing on a statistical basis as required by 47CFR §2.909. Operation is subject to the following two conditions: (1) this device may not cause harmful interference, and (2) this device must accept any interference received, including interference that may cause undesired operation.

Trade Name: EPSON
Type of Product: LCD Projector
Model: PowerLite 5600p/7600p

FCC Compliance Statement

For United States Users

This equipment has been tested and found to comply with the limits for a Class B digital device, pursuant to Part 15 of the FCC Rules. These limits are designed to provide reasonable protection against harmful interference in a residential installation. This equipment generates, uses, and can radiate radio frequency energy and, if not installed and used in accordance with the instructions, may cause harmful interference to radio or television reception. However, there is no guarantee that interference will not occur in a particular installation. If this equipment does cause interference to radio and television reception, which can be determined by turning the equipment off and on, the user is encouraged to try to correct the interference by one or more of the following measures:

- Reorient or relocate the receiving antenna.
- Increase the separation between the equipment and receiver.
- Connect the equipment into an outlet on a circuit different from that to which the receiver is connected.
- Consult the dealer or an experienced radio/TV technician for help.

WARNING

The connection of a non-shielded equipment interface cable to this equipment will invalidate the FCC Certification of this device and may cause interference levels which exceed the limits established by the FCC for this equipment. It is the responsibility of the user to obtain and use a shielded equipment interface cable with this device. If this equipment has more than one interface connector, do not leave cables connected to unused interfaces. Changes or modifications not expressly approved by the manufacturer could void the user's authority to operate the equipment.

For Canadian Users

This Class B digital apparatus meets all requirements of the Canadian Interference-Causing Equipment Regulations.

Cet appareil numérique de la classe B respecte toutes les exigences du Règlement sur le matériel brouilleur du Canada.

C *Technical Specifications*

General

Type of display	Poly-silicon Thin Film Transistor (TFT)
Size of liquid crystal panels	Diagonal: 1.3 inches (33.6 mm) Aspect ratio: 4:3 (horizontal:vertical)
Resolution	1024 × 768 pixels (PowerLite 7600p) 800 × 600 pixels (PowerLite 5600p)
Color reproduction	24 bit, 16.8 million colors
Brightness	2200 lumens (ANSI)
Contrast ratio	PowerLite 7600p: 400:1 PowerLite 5600p: 300:1
Image size	22 to 300 inches
Lens	F=1.7 to 2.3, f=49 to 63 mm
Zoom ratio	1:1.3
Keystone correction angle	± 30° (maximum)
Projection distance	3.6 to 47.9 feet (1.1 to 14.6 meters)
Projection method	Front, rear, upside-down (ceiling mount)
Internal speaker system	3-watt stereo speakers
Noise level	36 dB

Projection Lamp

Type	UHE (Ultra High Efficiency)
Power consumption	200 W
Lamp life	About 1500 hours
Part number	ELPLP12

Remote Control

Range	32.8 feet (10 meters)
Batteries	Alkaline AA (2)

Mouse Compatibility

Supports PS/2, USB, serial, and ADB

Remote IR Receiver

Supports EPSON Remote IR Receiver, 10-foot (3-meter) cable (typically used for rear screen projection)

Dimensions

Height	6.1 inches (156 mm)
Width	11.0 inches (280 mm)
Depth	15.9 inches (403 mm)
Weight	14.9 lb (6.8 kg)

Electrical

Rated frequency	50/60 Hz
Power supply	100 to 120 VAC, 3.4 A 200 to 240 VAC, 1.7 A
Power consumption	Operating: 285 W Standby: 9 W

Environmental

Temperature	Operating: 41 to 104 °F (5 to 40 °C) Storage: 14 to 140 °F (-10 to 60 °C)
Humidity	Operating: 20 to 80% RH, non-condensing Storage: 10 to 90% RH, non-condensing

Safety

United States	FCC Part 15B Class B UL1950 Rev. 3
Canada	DOC ICES003 Class B CSA C22.2 No. 950 Rev. 3
CE Marking	Directive 89/336/EEC, 92/31/EEC EN 60950

Compatible Video Formats

The projector supports NTSC, HDTV, PAL, and SECAM international video standards, as well as the monitor display formats listed below.

To project images output from a computer, the computer's video card must be set at a refresh rate (vertical frequency) that's compatible with the projector; see the following table for compatible formats. Some images are automatically resized to display in the projector's native format (XGA for the PowerLite 7600p, SVGA for the PowerLite 5600p). The frequencies of some computers may not allow images to display correctly; see your computer's documentation for details.

Mode	Refresh Rate (Hz)	Resolution
VGACGA	70	640 × 400
VGAEGA	70	640 × 350
VGA60	59.94	640 × 480
VGA72	72.809	640 × 480
VGA75	75	640 × 480
VGA85	85.008	640 × 480

Mode	Refresh Rate (Hz)	Resolution
NEC400	56.65	640 × 400
SVGA56	56.25	800 × 600
SVGA60	60.317	800 × 600
SVGA72	72.188	800 × 600
SVGA75	75	800 × 600
SVGA85	85.061	800 × 600
XGA43i	86.958	1024 × 768
XGA60	60.004	1024 × 768
XGA70	70.069	1024 × 768
XGA75	75.029	1024 × 768
XGA85	84.997	1024 × 768
SXGA1—70	70.012	1152 × 864
SXGA1—75	75	1152 × 864
SXGA1—85	84.999	1152 × 864
SXGA2—60	60	1280 × 960
SXGA2—75	75	1280 × 960
SXGA2—85	85.002	1280 × 960
SXGA3—43i	86.871	1280 × 1024
SXGA3—60	60.02	1280 × 1024
SXGA3—75	75.025	1280 × 1024
SXGA3—85	85.024	1280 × 1024
UXGA48i	96.08	1600 × 1200
UXGA60	60	1600 × 1200
UXGA65	65	1600 × 1200
UXGA70	70	1600 × 1200
UXGA75	75	1600 × 1200
UXGA80	80	1600 × 1200
UXGA85	85	1600 × 1200

Mode	Refresh Rate (Hz)	Resolution
MACLC13	66.62	640 × 480
MAC II 13	66.67	640 × 480
MAC16	74.55	832 × 624
MAC19—60	59.28	1024 × 768
MAC19	74.93	1024 × 768
MAC21	75.062	1152 × 870
HDTV480P (ANSI/SMPTE)	59.94	720 × 483
HDTV480P (ATSC)	59.94	704 × 480
HDTV480I (ANSI/SMPTE)	59.94	720 × 487
HDTV480I (ATSC)	59.94	704 × 480
HDTV720P (SMPTE)	59.94	1280 × 720
HDTV1080P (ANSI/SMPTE)	59.94	1920 × 1080
HDTV480I (ANSI/SMPTE)	59.94	1920 × 1080
NTSC (SVGA)	60	800 × 438
NTSC (XGA)	60	1024 × 438
PAL (SVGA)	50	800 × 512
PAL (XGA)	50	1024 × 512
SECAM (SVGA)	50	800 × 512
SECAM (XGA)	50	1024 × 512

Interface Connectors

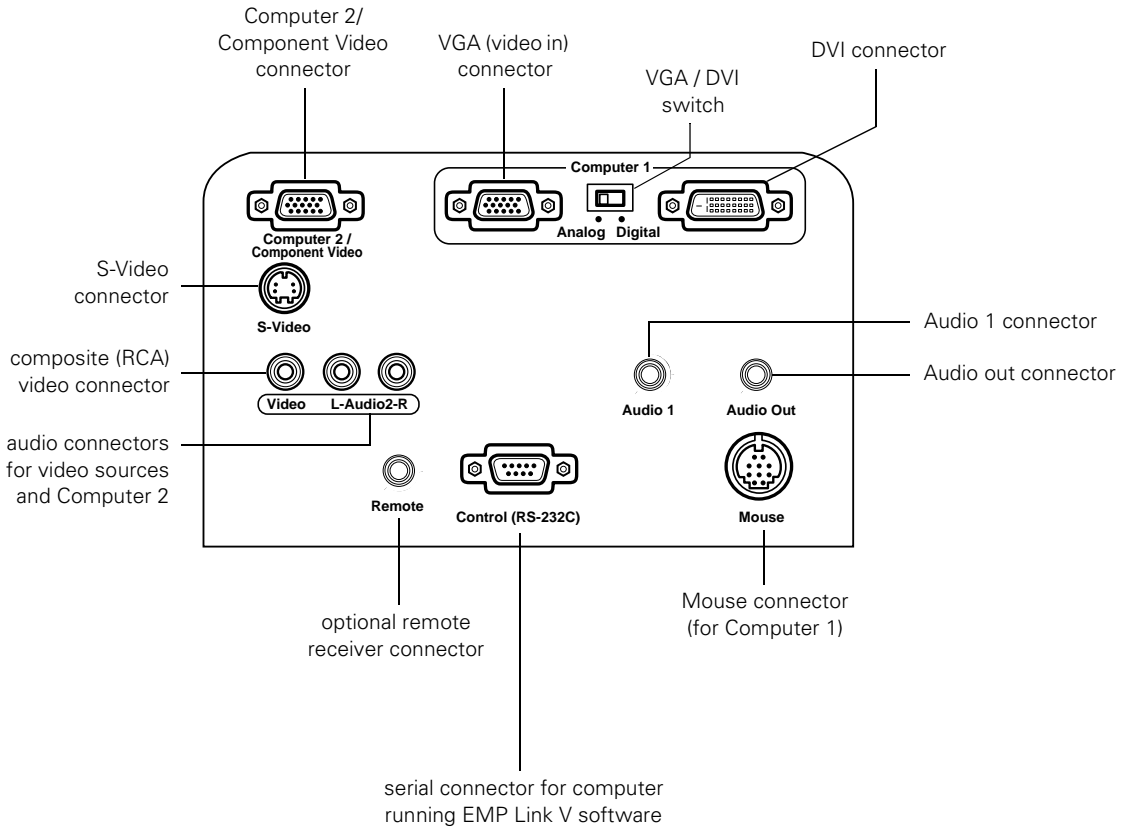

Computer Video Port Pin Assignments

The Computer 1 analog port (VGA) and the Monitor Out port are female video RGB, 15-pin micro-D-style connectors. Here are their pin assignments:

Pin no.	Computer 1 port	Monitor Out port
1	Red video	Red out / red video
2	Green video	Green out / green video
3	Blue video	Blue out / blue video
4	Monitor (ID bit 2)	Reserved
5	GND	GND
6	Red video GND	GND
7	Green video GND	GND
8	Blue video GND	GND
9	+5 V	Reserved
10	Synchronous GND	GND
11	Monitor (ID bit 0)	Reserved
12	SDA	Reserved
13	Horizontal sync	Horizontal sync
14	Vertical sync	Vertical sync
15	Reserved	Vertical sync

Image Size and Projection Distance

Use the tables below to estimate how far to place the projector from the screen. Since the size of the image can be changed by rotating the zoom ring, a range of distance is given for each screen size.

Note that if you tilt the projector upward by extending the feet or use electronic keystone correction, your image size may vary.

Standard Lens

Diagonal screen size	Distance
30 inches	3.6 to 4.6 feet (1.1 to 1.4 meters)
60 inches	7.2 to 9.5 feet (2.2 to 2.9 meters)
100 inches	12.1 to 15.7 feet (3.7 to 4.8 meters)
200 inches	24.9 to 31.8 feet (7.6 to 9.7 meters)
300 inches	36.4 to 47.9 feet (11.1 to 14.6 meters)

Long Throw Zoom Lens (ELPAL01)

Diagonal screen size	Distance
30 inches	4.23 to 5.71 feet (1.29 to 1.74 meters)
60 inches	9.06 to 11.94 feet (2.76 to 3.64 meters)
100 inches	15.45 to 20.28 feet (4.71 to 6.18 meters)
200 inches	31.46 to 41.08 feet (9.59 to 12.52 meters)
300 inches	47.44 to 61.88 feet (14.46 to 18.86 meters)

Wide Angle Lens (ELPAW01)

Diagonal screen size	Distance
30 inches	2.49 to 3.35 feet (0.76 to 1.02 meters)
60 inches	5.25 to 6.96 feet (1.60 to 2.12 meters)
100 inches	8.96 to 11.8 feet (2.73 to 3.59 meters)
200 inches	18.1 to 23.8 feet (5.53 to 7.26 meters)
300 inches	27.3 to 35.8 feet (8.31 to 10.90 meters)

Index

A

- A/V Mute, 29, 35, 52, 54
- About menu, 42, 55 to 56
- Accessories, 7 to 8, 76
- Adobe Acrobat Reader, 3 to 4
- Advanced menu, 42, 54 to 55
- Air filter, cleaning and replacing, 59 to 60
- Anti-theft device, 8, 11
- Aspect ratio, 28, 95
- Audio
 - adjusting tone, 48 to 49
 - adjusting volume, 29, 34, 48 to 49
 - cables, 6
 - connecting desktop, 82, 85
 - connecting laptop, 14
 - connecting second computer, 86
 - connecting video device, 19
 - menu, 42, 48 to 49
 - outputting to external sound system, 79
 - problems, 66, 73
 - turning off (using A/V Mute), 29, 35
- Audio Out jack, 79
- Auto button, 28, 46

B

- Bar tool, 39
- Bass, adjusting, 48 to 49
- Batteries, installing, 32
- Blank screen, 24 to 25
- BNC cable, 7, 15
- Box tool, 38
- Brightness, 1, 95
- Brightness setting, 46

C

- Cables
 - audio, 6, 14, 19, 79, 82, 85
 - computer, 6 to 8, 12, 80, 83 to 84
 - mouse, 6 to 8, 13, 81, 84

- Cables (continued)
 - purchasing, 8
 - video, 6 to 8, 15 to 18
- Capturing image, 51 to 52
- Carrying case, 8, 63
- Ceiling mount, 8, 78
- Cleaning
 - air filter, 59 to 60
 - lens, 58
 - projector case, 58
- Component video cable, 7, 15
- Composite video cable, 15
- Computer
 - cable, 6
 - connector pin assignments, 101
 - saving settings for, 47 to 48
- Computers supported, 1
- Connecting projector
 - to a BNC computer source, 18
 - to a desktop Macintosh, 83 to 85
 - to a desktop PC, 80 to 82
 - to a DVI computer source, 88
 - to a high-end workstation, 87
 - to a laptop, 12 to 14
 - to a second computer, 86
 - to a video source, 15 to 18
- Contrast setting, 46

D

- Declaration of Conformity, 92
- Default settings, restoring, 44, 56
- Desktop adapter, Macintosh, 83 to 84
- Desktop computer, connecting, 80 to 82, 83 to 85
- Digital visual interface, *see* DVI
- Dimensions, 96
- Display formats, 97 to 99
- Distance from projector to screen, 10, 102 to 103
- Drawing on the screen, 37 to 39

DVI (Digital Visual Interface)
cable, 7, 8
source, connecting to, 88

E

Effect menu, 42, 49 to 50
Electrical specifications, 96
EMP Link V, 3, 78 to 79
Enter button, 33
Environmental specifications, 97
EPSON
accessories, 8, 76
PrivateLine Support, 5, 75
technical support, 4, 75 to 76
Esc button, 40
E-Zoom button, 35

F

FCC compliance statement, 93
Filter, *see* Air filter
Focusing, 26
Foot release levers, 27
Freeze button, 35

G

Gamma setting, 46

H

Height of image, adjusting, 27
Help, 4 to 5, 66, 75 to 76
Help button, 66
Highlighting tools, 37 to 39, 49 to 50

I

iBook, connecting to, 12
iMac, connecting to, 7
Image
adjusting, 26 to 28, 45 to 47
capturing and saving in projector, 51 to 52
correcting shape, 27, 53, 71
focusing, 26
height, adjusting, 27
positioning, 27, 46

Image (continued)
problems, 68 to 73
raising, 27
resizing, 28
size and projection distance, 10, 102 to 103
turning off (using A/V Mute), 29, 35
zooming, 26, 35
Installing projector, 78 to 79

K

Kensington anti-theft device, 8, 11
Keystone correction, 27, 71, 95

L

Lamp
number of hours used, 55
replacing, 60 to 62
specifications, 96
status light, 67
timer, resetting, 62
Language setting, 66
Laptop computer
connecting to, 12 to 14
displaying on, 25, 69
Lens
cleaning, 58
image size and projection distance,
102 to 103
options, 8, 102 to 103
specifications, 95
Light button (remote control), 32
Lights, status, 67 to 68
Lines, drawing on screen, 39
Logo, saving on projector, 51 to 52

M

Macintosh
connecting, 83 to 85
desktop adapter, 83 to 84
Manuals, 3 to 5
Menus
About, 42, 55 to 56
Advanced, 42, 54 to 55

Menus (continued)

- Audio, 42, 48 to 49
- changing settings, 42 to 44
- Effect, 42, 49 to 50
- Reset All, 42, 56
- Setting, 42, 53 to 54
- User's Logo, 42, 51 to 52
- using, 42 to 44
- Video, 42, 45 to 47

Monitor Out pin assignments, 101

N

No-Signal Msg setting, 53

O

Options for projector, 8

P

- P in P (picture in picture) button, 36
- Picture source, selecting, 29, 34
- Picture, *see* Image
- Picture-in-picture video source, selecting, 53
- Pin assignments, connector, 101
- Pointer tool, 37
- Positioning
 - image, 27
 - projector, 10 to 11, 102 to 103
- Power
 - button, 23
 - consumption, 96
 - status light, 67
 - supply specification, 96
- Presenters Online, 4, 75
- Preset
 - button, 48
 - option, 47 to 48
- PrivateLine Support, 5, 75
- Projection lamp, *see* Lamp
- Projector
 - carrying case, 8, 63
 - cleaning, 58
 - connections, *see* Connecting projector
 - controlling from computer, 3, 78 to 79

Projector (continued)

- distance from screen, 10, 95, 102 to 103
 - feet, adjusting height with, 27
 - installing, 78 to 79
 - lamp specifications, 96
 - options, 8
 - positioning, 10 to 11, 102 to 103
 - resolution, 1, 95
 - software, 4
 - transporting, 63
 - troubleshooting, 65 to 73
 - turning off, 30
 - turning on, 22
 - unpacking, 6 to 7
 - viewing information about, 55
- Prompt setting, 53
- PS/2 mouse cable, 6

R

- Raising image, 27
- Rear-screen projection, 78
- Registration, 5
- Remote control
 - as wireless mouse, 40
 - light button, 32
 - numbered buttons, 37
 - problems, 74
 - specifications, 96
 - troubleshooting, 91
 - turning on, 32
 - using, 31 to 40
- Replacing
 - air filter, 59 to 60
 - lamp, 60 to 62
- Resetting lamp timer, 62
- Resetting menu options, 42, 44, 56
- Resizing image, 28
- Resolution, 1, 47, 95

S

- Safety instructions, 89 to 90
- Screen
 - blank, 24 to 25
 - distance from projector, 10, 102 to 103

Screen image, *see* Image
Setting menu, 42, 53 to 54
Sharpness setting, 46
Sleep mode, 30
Software, 4
Sound
 adjusting tone, 48 to 49
 adjusting volume, 34, 48 to 49
 problems, 66, 73
 turning off (using A/V Mute), 29, 35
Source, selecting, 29, 34
Speakers
 external, connecting to, 79
 internal, specifications, 95
Special effects buttons, 37 to 39
Specifications
 brightness, 1, 95
 dimensions, 96
 electrical, 96
 environmental, 97
 general, 95
 lamp, 96
 lens, 95
 remote control, 96
 resolution, 1, 95
 safety, 97
 video formats, 97 to 99
Spotlight tool, 38
Startup screen, creating, 51 to 52
Status lights, 67 to 68
Stopping action, 35
Support, *see* Technical support
S-Video cable, 7, 15
Switching picture source, 29, 34
Synchronization, adjusting, 28, 46, 72

T

Technical support, 4, 75 to 76
Temperature
 requirements, 97
 status light, 67 to 68
Tone setting, 48 to 49
Tracking, adjusting, 28, 46, 72
Transporting projector, 63

Treble, adjusting, 48 to 49
Troubleshooting
 blank screen, 24 to 25
 image problems, 68 to 73
 remote control problems, 74
 sound problems, 73
 status lights, 67 to 68
 using on-screen help, 66
Turning off picture (using A/V Mute), 29, 35
Turning off projector, 30
Turning on projector, 22

U

Unpacking projector, 6 to 7
USB mouse cable, 6
User's Logo menu, 42, 51 to 52

V

Video
 button, 34
 cables, 6 to 8
 display settings, viewing, 55
 formats, supported, 1, 97 to 99
 menu, 42, 45 to 47
 picture in picture, 53
 port pin assignments, 101
 selecting source, 29, 34
Video sources, connecting projector to,
 15 to 18
Volume
 adjusting, 29, 34
 setting, 48 to 49

W

Warning lights, 67 to 68
Warranty, 5
Workstations, connecting projector to, 87

Z

Zoom ratio, 95
Zooming image, 26, 35